

**Güçlü Çözümler,
Güvenilir Performans**

Powerful Solutions, Reliable Performance

2024/25

ENDÜSTRİYEL ÜRÜN KATALOĞU
INDUSTRIAL PRODUCT CATALOGUE

since 1983
Mutlusan®
electric

YENİ
NEW

Cüvenilirlik sorunlarını ortadan kaldırmak için çoklu bağlantı
Multiple connection to eliminate reliability problems

Daha iyi görünürlük ve tanımlama için yükseltilmiş grup işareti
Raised group marker for better visibility & identification

Takılabilir jumper'lar kullanılarak köprüleme için iki bağımsız sıra. Jumper'lar, kısa pozisyonları belirtmek için keçeli kalemle işaretlenebilir
Two independent rows for bridging using pluggable jumpers. Jumpers can be marked with a felt tip pen to indicate shorted positions

8 Seviyeli Mareşalleme Terminal Bloğu
8 Level Marshalling Terminal Block

1,5 mm² kablolar için 3,5 mm kalınlığında en ince terminal bloğu
Thinnest Terminal Block in 3.5 mm thickness for 1.5 mm² wires

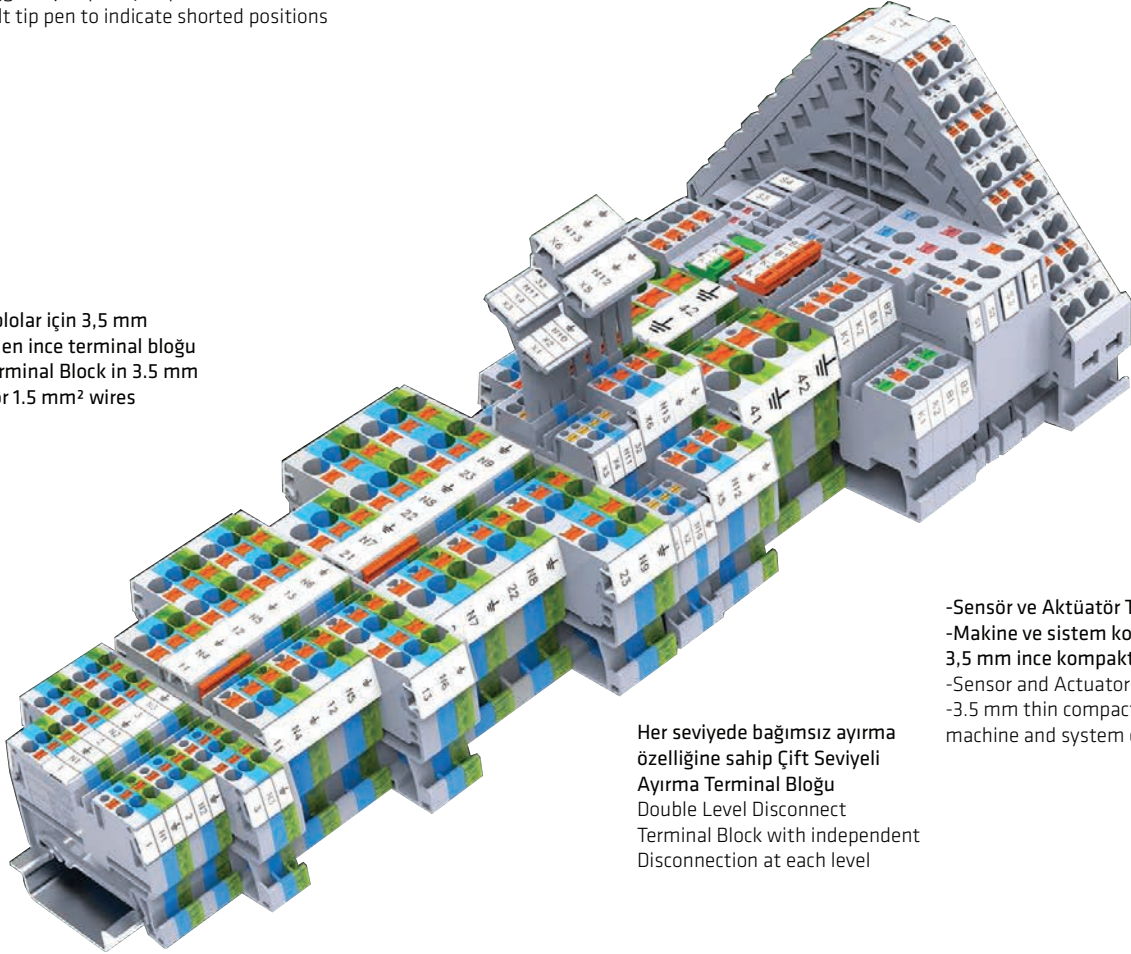

-Sensör ve Aktüatör Terminal Bloğu
-Makine ve sistem kontrolörü için 3,5 mm ince kompakt Terminaller
-Sensor and Actuator Terminal Block
-3.5 mm thin compact Terminals for machine and system controller

Her seviyede bağımsız ayırma özelliğine sahip Çift Seviyeli Ayırma Terminal Bloğu
Double Level Disconnect Terminal Block with independent Disconnection at each level

Endüstri standartlarına göre sarı-yeşil renk kodlu topraklama kablolarını sonlandırmak için Topraklama Terminal Blokları
Earthing Terminal Blocks for terminating earthing wires coded yellow-green colour as per industry standards

ŞALT ÜRÜNLERİ / SWITCHGEAR	02
RAY KLEMENSLER / RAIL TERMINAL BLOCKS	28
PROMEX DELİKLİ KABLO KANALLARI / PROMEX SLOTTED TRUNKING	36
ABS PLASTİK PANO VE AKSESUARLARI / ABS PLASTIC PANELS AND ACCESSORIES	46
TERMOSTAT VE HİGROSTAT / THERMOSTAT AND HYGROSTAT	49
TEPE FANLARI / ROOF FANS	51
UV DAYANIMLI POLYAMİD SPİRALLER / UV RESISTANCE POLYAMİDE SPIRALS	52
POLYAMİD SPİRAL RAKORLARI / POLYAMİD SPİRAL GLAND	55
R-MEKS PLASTİK KABLO RAKORLARI / R-MEKS PLASTIC CABLE GLAND	56
PROMEX PLASTİK KABLO KANALLARI / PROMEX PLASTIC CABLE GLAND	57
KABLO BAĞLARI / CABLESTRAPS	60
KROŞE VE KLİPSLER / CROCHET AND CLIPSES	61
KELEPÇELER, ETİKETLER, HELEZON PANO SPİRALLERİ / CLAMPS, LABELS, HELICAL PANEL SPIRALS	61
TOPRAKLAMA KLEMENS VE DAĞITIM ÜNİTESİ / GROUNDİNG TERMİNAL AND DISTRIBUTION UNITS	62
YÜKSÜKLER / TERMINALS	64
BARALAR VE RAYLAR / BUSBARS AND RAILS	68
SKP ÇEŞİTLERİ / CABLE TERMINAL LUGS	69
SANAYİ FİŞ-PRİZ GRUBU / PLUG SOCKET GROUP	70
CEE NORM SANAYİ TİPİ FİŞ-PRİZ GRUBU / MUTLUSAN CEE NORM PLUG-SOCKET GROUP	74
TERMOPLASTİK BUATLAR / THERMOPLASTIC JUNCTION BOXES	76
KOMBİNASYON PANOLARI / COMBINATION BOARDS	79
SİNYAL VE KUMANDA BUTONLARI / SIGNAL AND CONTROL BUTTONS	81
BUTON AKSESUARLARI / BUTTON ACCESSORIES	90
KUMANDA VE VİNÇ KUTULARI / CONTROL BOXES AND CRANE CONTROL BOXES	96

YENİ
NEW

Şalt Grubu Switchgear



Güvenliğiniz İçin For Your Safety



CE

TSE

REGISTERED COMPANY
ISO
14001

REGISTERED COMPANY
ISO
9001:
2008

REGISTERED COMPANY
OHSAS
18001

Made in Türkiye

 @mutusanplastikelektrik

 @mutusanelectric

 @mutusanelk

 @mutusanelektrik



Otomatik Sigorta

Miniature Circuit Breaker (MCB)

Farklı amper değerlerinde üretilmiş olan bu otomatik sigortalar ya da diğer adıyla minyatür devre kesiciler, elektrik tesisatını ve sistemi aşırı akım ve kısa devrelere karşı korumak amacıyla tasarlanmış koruma ve anahtarlama devre elemanlarıdır. Devreden geçen akım, sigortaların nominal akımlarının belirli bir seviye üstüne çıkması durumunda ya da devrede bir kısa devre meydana gelmesi durumunda otomatik sigortalar elektrik bağlantısını keserek kendinden sonraki sistemi korumaya almaktadır.

Miniature circuit breakers, produced in different amperage values, are protection and switching circuit elements designed to protect the electrical installation and system against overcurrent and short circuits. If the current flowing through the circuit exceeds a certain level of the nominal current of the MCBs or if a short circuit occurs in the circuit, automatic MCBs protect the next system by cutting off the electrical connection.

YENİ
NEW



Yüksek kaliteli, yanmaz,
960 C polyamid 66 malzeme

The high quality unflam- mable,
960 C polyamide 66 material

Renkli kontak konumu göstergesi,
cihazın durumunun ve yalıtım
fonksiyonunun görsel olarak
gösterilmesini sağlar.

Color coded contact position indicator
provides visual indication of the device
status and insulation function

B ve C tipi seçenekleriyle.
B and C type tripping curve selections.

10kA'e kadar kesme kapasitesi.
Breaking capacity up to 10kA

Kurma kolunun pozisyonu ON-I
konumunda akıma açık, O-OFF
durumunda akıma kapalıdır.

The position of the handle is open to
current in the ON-I position, and closed
to current in the O-OFF position.

- Yüksek çerçeve seviyeli çift kırılma noktası (18mm genişlik, 125A'ya kadar modül), yüksek kesme kapasitesi (10kA'e kadar).
- Hata korumalı terminal bloklarına sahip terminal ve kontak konumu gösteren pencere ile daha yüksek güvenlik.
- Akım korumalı kontak sistemi, manyetik üfleme ark seperatörü, ürünü ve ekipmanları yüksek kısa devre akımından korur, ürünlerin ark söndürme yeteneğini geliştirir, ardından kesme kapasitesinin artırılmasını sağlar.
- Gövde ve fonksiyon parçalarının tümü, yüksek alev geciktirici ve yüksek sıcaklık dayanımı, aynı zamanda darbeye dayanıklı PA66 polyamid malzemeden yapılmıştır.
- High frame level double breaking point (18mm width, module up to 125A), high breaking capacity (up to 10kA).
- Terminal with error protected terminal blocks, and higher safety with contact position indicating window.
- Current limited contact system, magnetic blow-out type arc extinguishing device, can avoid products and equipment from large short circuit current, and improve the arc extinguishing ability of products, then make sure the enhancement of breaking capacity.
- The mold and function parts are all made of PA66 polyamide material, which is highly flame retardant and high temperature resistance, also impact resistant.

İÇ YAPI STRUCTURE

Kablo bağlantısı için yüksek torklu terminal
High torque terminal for line / load power.

Bimetal
Bi-metallic strip.

Kurma kolu mekanizması
Quick make actuator mechanism

Gümüş/Bakır alaşımli kontak
Silver alloy contact

Bobin Sargısı
Coil selenoid

Hızlı&Verimli söndürücü ark
Quick & Efficient arc extinguisher

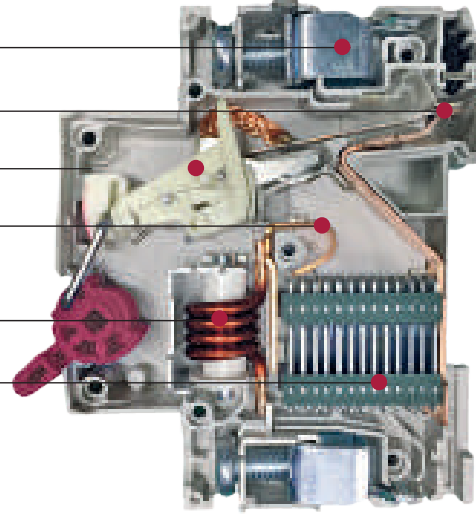

Boyutlar Dimensions

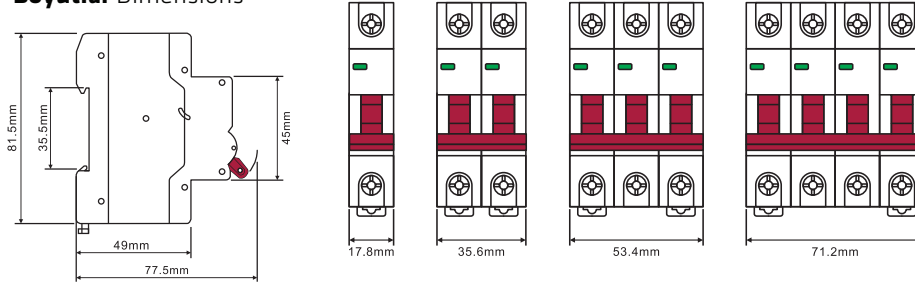

TEKNİK ÖZELLİKLER TECHNICAL SPECIFICATIONS

TIP TYPE			MTS-6				MTS-10				MTS-10H			
KUTUP SAYISI NO OF POLES			1	2	3	4	1	2	3	4	1	2	3	4
NOMINAL AKIM DERECESİ (30°C'de) RATED NOMINAL CURRENT (at 30°C)	In	A	1,2,3,4,5,6,10,16, 20,25,32,40,50,63				1,2,3,4,5,6,10,16, 20,25,32,40,50,63				80,100,125			
ANLIK TRİPPING SINIFI INSTANT TRIPPING CLASS			(B:3-5xIn) (C:5-10xIn) (D:10-20xIn)				(B:3-5xIn) (C:5-10xIn) (D:10-20xIn)				(C:5-10xIn)			
NOMINAL ÇALIŞMA GERİLİMİ RATED OPERATING VOLTAGE	Ue	AC (V)	230/400		400		230/400		400		230/400		400	
GÜÇ KAYNAĞI POWER SUPPLY			AC				AC				AC			
YALITIM GERİLİMİ DERECESİ RATED INSULATION VOLTAGE	Ui	V	690				690				690			
DARBE DAYANIM GERİLİMİ RATED IMPULSE WITHSTANDING VOLTAGE	Uimp	kV	6				6				6			
KISA DEVRE KESME KAPASİTESİ DERECESİ RATED SHORT CIRCUIT BREAKING CAPACITY	Ics	kA	6				6				6			
ENERJİ SINIRLAYICI SINIF ENERGY LIMITING CLASS			3				3				3			
ELEKTRİKSEL ÖMÜR (ÇALIŞMA) ELECTRICAL LIFE (WORKING)	op.	230V	5000				6000				5000			
MEKANİK ÖMÜR (ÇALIŞMA) MECHANICAL LIFE (WORKING)	op.		20000				20000				20000			
KORUMA SINIFI PROTECTION CLASS			IP 20				IP 20				IP 20			
ÇALIŞMA SICAKLIĞI OPERATING TEMPERATURE		°C	-30 to +60				-30 to +60				-30 to +60			
DEPOLAMA SICAKLIĞI STORAGE TEMPERATURE		°C	-40 to +70				-40 to +70				-40 to +70			
RENK COLOUR			RAL 7035				RAL 7035				RAL 7035			
MONTAJ (EN 60715) ASSEMBLY (EN 60715)			35mm DIN Rail				35mm DIN Rail				35mm DIN Rail			
MIN. MAX. BAĞLANTI KESİTİ MIN. MAX. CONNECTION SECTION		mm ²	1-25				1-25				1-25			
MAKSİMUM SIKMA TORKU MAXIMUM CLAMPING TORQUE		Nm	2,5				2,5				3,5			

B TİPİ OTOMATİK SİGORTALAR - 6kA

B TYPE MINIATURE CIRCUIT BREAKER (MCB)

YENİ
NEW

MTS06 SERİSİ

TEKNİK BİLGİLER

TECHNICAL INFORMATION



KOD CODE	KUTUP SAYISI NO OF POLES	AÇIKLAMA DESCRIPTION	KUTU BOX	KOLİ PARCEL	KUTU AĞIRLIK WEIGHT kg	KUTU HACİM VOLUME m ³
MTS06-1001B	1P	6KA 1P 1A B TİPİ OTOMATİK SİGORTA B TYPE MINIATURE CIRCUIT BREAKER (MCB)	12	240	1,164	0,001845984
MTS06-1002B	1P	6KA 1P 2A B TİPİ OTOMATİK SİGORTA B TYPE MINIATURE CIRCUIT BREAKER (MCB)	12	240	1,16196	0,001845984
MTS06-1003B	1P	6KA 1P 3A B TİPİ OTOMATİK SİGORTA B TYPE MINIATURE CIRCUIT BREAKER (MCB)	12	240	1,16196	0,001845984
MTS06-1004B	1P	6KA 1P 4A B TİPİ OTOMATİK SİGORTA B TYPE MINIATURE CIRCUIT BREAKER (MCB)	12	240	1,19796	0,001845984
MTS06-1005B	1P	6KA 1P 5A B TİPİ OTOMATİK SİGORTA B TYPE MINIATURE CIRCUIT BREAKER (MCB)	12	240	1,22196	0,001845984
MTS06-1006B	1P	6KA 1P 6A B TİPİ OTOMATİK SİGORTA B TYPE MINIATURE CIRCUIT BREAKER (MCB)	12	240	1,176	0,001845984
MTS06-1010B	1P	6KA 1P 10A B TİPİ OTOMATİK SİGORTA B TYPE MINIATURE CIRCUIT BREAKER (MCB)	12	240	1,176	0,001845984
MTS06-1016B	1P	6KA 1P 16A B TİPİ OTOMATİK SİGORTA B TYPE MINIATURE CIRCUIT BREAKER (MCB)	12	240	1,176	0,001845984
MTS06-1020B	1P	6KA 1P 20A B TİPİ OTOMATİK SİGORTA B TYPE MINIATURE CIRCUIT BREAKER (MCB)	12	240	1,188	0,001845984
MTS06-1025B	1P	6KA 1P 25A B TİPİ OTOMATİK SİGORTA B TYPE MINIATURE CIRCUIT BREAKER (MCB)	12	240	1,188	0,001845984
MTS06-1032B	1P	6KA 1P 32A B TİPİ OTOMATİK SİGORTA B TYPE MINIATURE CIRCUIT BREAKER (MCB)	12	240	1,2	0,001845984
MTS06-1040B	1P	6KA 1P 40A B TİPİ OTOMATİK SİGORTA B TYPE MINIATURE CIRCUIT BREAKER (MCB)	12	240	1,188	0,001845984
MTS06-1050B	1P	6KA 1P 50A B TİPİ OTOMATİK SİGORTA B TYPE MINIATURE CIRCUIT BREAKER (MCB)	12	240	1,188	0,001845984
MTS06-1063B	1P	6KA 1P 63A B TİPİ OTOMATİK SİGORTA B TYPE MINIATURE CIRCUIT BREAKER (MCB)	12	240	1,188	0,001845984
MTS06-2001B	2P	6KA 2P 1A B TİPİ OTOMATİK SİGORTA B TYPE MINIATURE CIRCUIT BREAKER (MCB)	6	120	1,17402	0,00184599
MTS06-2002B	2P	6KA 2P 2A B TİPİ OTOMATİK SİGORTA B TYPE MINIATURE CIRCUIT BREAKER (MCB)	6	120	1,17402	0,00184599
MTS06-2003B	2P	6KA 2P 3A B TİPİ OTOMATİK SİGORTA B TYPE MINIATURE CIRCUIT BREAKER (MCB)	6	120	1,158	0,00184599
MTS06-2004B	2P	6KA 2P 4A B TİPİ OTOMATİK SİGORTA B TYPE MINIATURE CIRCUIT BREAKER (MCB)	6	120	1,24002	0,00184599
MTS06-2005B	2P	6KA 2P 5A B TİPİ OTOMATİK SİGORTA B TYPE MINIATURE CIRCUIT BREAKER (MCB)	6	120	1,24002	0,00184599
MTS06-2006B	2P	6KA 2P 6A B TİPİ OTOMATİK SİGORTA B TYPE MINIATURE CIRCUIT BREAKER (MCB)	6	120	1,17402	0,00184599
MTS06-2010B	2P	6KA 2P 10A B TİPİ OTOMATİK SİGORTA B TYPE MINIATURE CIRCUIT BREAKER (MCB)	6	120	1,236	0,00184599
MTS06-2016B	2P	6KA 2P 16A B TİPİ OTOMATİK SİGORTA B TYPE MINIATURE CIRCUIT BREAKER (MCB)	6	120	1,296	0,00184599
MTS06-2020B	2P	6KA 2P 20A B TİPİ OTOMATİK SİGORTA B TYPE MINIATURE CIRCUIT BREAKER (MCB)	6	120	1,22202	0,00184599
MTS06-2025B	2P	6KA 2P 25A B TİPİ OTOMATİK SİGORTA B TYPE MINIATURE CIRCUIT BREAKER (MCB)	6	120	1,224	0,00184599
MTS06-2032B	2P	6KA 2P 32A B TİPİ OTOMATİK SİGORTA B TYPE MINIATURE CIRCUIT BREAKER (MCB)	6	120	1,206	0,00184599
MTS06-2040B	2P	6KA 2P 40A B TİPİ OTOMATİK SİGORTA B TYPE MINIATURE CIRCUIT BREAKER (MCB)	6	120	1,128	0,00184599
MTS06-2050B	2P	6KA 2P 50A B TİPİ OTOMATİK SİGORTA B TYPE MINIATURE CIRCUIT BREAKER (MCB)	6	120	1,19802	0,00184599
MTS06-2063B	2P	6KA 2P 63A B TİPİ OTOMATİK SİGORTA B TYPE MINIATURE CIRCUIT BREAKER (MCB)	6	120	1,14402	0,00184599
MTS06-3001B	3P	6KA 3P 1A B TİPİ OTOMATİK SİGORTA B TYPE MINIATURE CIRCUIT BREAKER (MCB)	4	80	1,166	0,001845988
MTS06-3002B	3P	6KA 3P 2A B TİPİ OTOMATİK SİGORTA B TYPE MINIATURE CIRCUIT BREAKER (MCB)	4	80	1,166	0,001845988
MTS06-3003B	3P	6KA 3P 3A B TİPİ OTOMATİK SİGORTA B TYPE MINIATURE CIRCUIT BREAKER (MCB)	4	80	1,17	0,001845988
MTS06-3004B	3P	6KA 3P 4A B TİPİ OTOMATİK SİGORTA B TYPE MINIATURE CIRCUIT BREAKER (MCB)	4	80	1,226	0,001845988
MTS06-3005B	3P	6KA 3P 5A B TİPİ OTOMATİK SİGORTA B TYPE MINIATURE CIRCUIT BREAKER (MCB)	4	80	1,202	0,001845988
MTS06-3006B	3P	6KA 3P 6A B TİPİ OTOMATİK SİGORTA B TYPE MINIATURE CIRCUIT BREAKER (MCB)	4	80	1,134	0,001845988
MTS06-3010B	3P	6KA 3P 10A B TİPİ OTOMATİK SİGORTA B TYPE MINIATURE CIRCUIT BREAKER (MCB)	4	80	1,176	0,001845988
MTS06-3016B	3P	6KA 3P 16A B TİPİ OTOMATİK SİGORTA B TYPE MINIATURE CIRCUIT BREAKER (MCB)	4	80	1,196	0,001845988
MTS06-3020B	3P	6KA 3P 20A B TİPİ OTOMATİK SİGORTA B TYPE MINIATURE CIRCUIT BREAKER (MCB)	4	80	1,116	0,001845988
MTS06-3025B	3P	6KA 3P 25A B TİPİ OTOMATİK SİGORTA B TYPE MINIATURE CIRCUIT BREAKER (MCB)	4	80	1,096	0,001845988
MTS06-3032B	3P	6KA 3P 32A B TİPİ OTOMATİK SİGORTA B TYPE MINIATURE CIRCUIT BREAKER (MCB)	4	80	1,104	0,001845988
MTS06-3040B	3P	6KA 3P 40A B TİPİ OTOMATİK SİGORTA B TYPE MINIATURE CIRCUIT BREAKER (MCB)	4	80	1,112	0,001845988
MTS06-3050B	3P	6KA 3P 50A B TİPİ OTOMATİK SİGORTA B TYPE MINIATURE CIRCUIT BREAKER (MCB)	4	80	1,168	0,001845988
MTS06-3063B	3P	6KA 3P 63A B TİPİ OTOMATİK SİGORTA B TYPE MINIATURE CIRCUIT BREAKER (MCB)	4	80	1,172	0,001845988
MTS06-4001B	4P	6KA 4P 1A B TİPİ OTOMATİK SİGORTA B TYPE MINIATURE CIRCUIT BREAKER (MCB)	3	60	1,22199	0,001845987
MTS06-4002B	4P	6KA 4P 2A B TİPİ OTOMATİK SİGORTA B TYPE MINIATURE CIRCUIT BREAKER (MCB)	3	60	1,16799	0,001845987
MTS06-4003B	4P	6KA 4P 3A B TİPİ OTOMATİK SİGORTA B TYPE MINIATURE CIRCUIT BREAKER (MCB)	3	60	1,15299	0,001845987
MTS06-4004B	4P	6KA 4P 4A B TİPİ OTOMATİK SİGORTA B TYPE MINIATURE CIRCUIT BREAKER (MCB)	3	60	1,23099	0,001845987
MTS06-4005B	4P	6KA 4P 5A B TİPİ OTOMATİK SİGORTA B TYPE MINIATURE CIRCUIT BREAKER (MCB)	3	60	1,19199	0,001845987
MTS06-4006B	4P	6KA 4P 6A B TİPİ OTOMATİK SİGORTA B TYPE MINIATURE CIRCUIT BREAKER (MCB)	3	60	1,17699	0,001845987
MTS06-4010B	4P	6KA 4P 10A B TİPİ OTOMATİK SİGORTA B TYPE MINIATURE CIRCUIT BREAKER (MCB)	3	60	1,14699	0,001845987
MTS06-4016B	4P	6KA 4P 16A B TİPİ OTOMATİK SİGORTA B TYPE MINIATURE CIRCUIT BREAKER (MCB)	3	60	1,12899	0,001845987
MTS06-4020B	4P	6KA 4P 20A B TİPİ OTOMATİK SİGORTA B TYPE MINIATURE CIRCUIT BREAKER (MCB)	3	60	1,15299	0,001845987
MTS06-4025B	4P	6KA 4P 25A B TİPİ OTOMATİK SİGORTA B TYPE MINIATURE CIRCUIT BREAKER (MCB)	3	60	1,092	0,001845987
MTS06-4032B	4P	6KA 4P 32A B TİPİ OTOMATİK SİGORTA B TYPE MINIATURE CIRCUIT BREAKER (MCB)	3	60	1,095	0,001845987
MTS06-4040B	4P	6KA 4P 40A B TİPİ OTOMATİK SİGORTA B TYPE MINIATURE CIRCUIT BREAKER (MCB)	3	60	1,125	0,001845987
MTS06-4050B	4P	6KA 4P 50A B TİPİ OTOMATİK SİGORTA B TYPE MINIATURE CIRCUIT BREAKER (MCB)	3	60	1,206	0,001845987
MTS06-4063B	4P	6KA 4P 63A B TİPİ OTOMATİK SİGORTA B TYPE MINIATURE CIRCUIT BREAKER (MCB)	3	60	1,19199	0,001845987

C TİPİ OTOMATİK SİGORTALAR - 6kA

C TYPE MINIATURE CIRCUIT BREAKER (MCB)

YENİ
NEW



MTS06 SERİSİ

TEKNİK BİLGİLER
TECHNICAL INFORMATION

KOD CODE	KUTUP SAYISI NO OF POLES	AÇIKLAMA DESCRIPTION	KUTU BOX	KOLİ PARCEL	KUTU AĞIRLIK BOX WEIGHT kg	KUTU HACİM BOX VOLUME m ³
MTS06-1001C	1P	6KA 1P 1A C TİPİ OTOMATİK SİGORTA C TYPE MINIATURE CIRCUIT BREAKER (MCB)	12	240	1,16196	0,001845984
MTS06-1002C	1P	6KA 1P 2A C TİPİ OTOMATİK SİGORTA C TYPE MINIATURE CIRCUIT BREAKER (MCB)	12	240	1,16196	0,001845984
MTS06-1003C	1P	6KA 1P 3A C TİPİ OTOMATİK SİGORTA C TYPE MINIATURE CIRCUIT BREAKER (MCB)	12	240	1,16196	0,001845984
MTS06-1004C	1P	6KA 1P 4A C TİPİ OTOMATİK SİGORTA C TYPE MINIATURE CIRCUIT BREAKER (MCB)	12	240	1,19796	0,001845984
MTS06-1005C	1P	6KA 1P 5A C TİPİ OTOMATİK SİGORTA C TYPE MINIATURE CIRCUIT BREAKER (MCB)	12	240	1,22196	0,001845984
MTS06-1006C	1P	6KA 1P 6A C TİPİ OTOMATİK SİGORTA C TYPE MINIATURE CIRCUIT BREAKER (MCB)	12	240	1,176	0,001845984
MTS06-1010C	1P	6KA 1P 10A C TİPİ OTOMATİK SİGORTA C TYPE MINIATURE CIRCUIT BREAKER (MCB)	12	240	1,176	0,001845984
MTS06-1016C	1P	6KA 1P 16A C TİPİ OTOMATİK SİGORTA C TYPE MINIATURE CIRCUIT BREAKER (MCB)	12	240	1,176	0,001845984
MTS06-1020C	1P	6KA 1P 20A C TİPİ OTOMATİK SİGORTA C TYPE MINIATURE CIRCUIT BREAKER (MCB)	12	240	1,188	0,001845984
MTS06-1025C	1P	6KA 1P 25A C TİPİ OTOMATİK SİGORTA C TYPE MINIATURE CIRCUIT BREAKER (MCB)	12	240	1,188	0,001845984
MTS06-1032C	1P	6KA 1P 32A C TİPİ OTOMATİK SİGORTA C TYPE MINIATURE CIRCUIT BREAKER (MCB)	12	240	1,19796	0,001845984
MTS06-1040C	1P	6KA 1P 40A C TİPİ OTOMATİK SİGORTA C TYPE MINIATURE CIRCUIT BREAKER (MCB)	12	240	1,188	0,001845984
MTS06-1050C	1P	6KA 1P 50A C TİPİ OTOMATİK SİGORTA C TYPE MINIATURE CIRCUIT BREAKER (MCB)	12	240	1,18596	0,001845984
MTS06-1063C	1P	6KA 1P 63A C TİPİ OTOMATİK SİGORTA C TYPE MINIATURE CIRCUIT BREAKER (MCB)	12	240	1,18596	0,001845984
MTS06-2001C	2P	6KA 2P 1A C TİPİ OTOMATİK SİGORTA C TYPE MINIATURE CIRCUIT BREAKER (MCB)	6	120	1,17402	0,00184599
MTS06-2002C	2P	6KA 2P 2A C TİPİ OTOMATİK SİGORTA C TYPE MINIATURE CIRCUIT BREAKER (MCB)	6	120	1,17402	0,00184599
MTS06-2003C	2P	6KA 2P 3A C TİPİ OTOMATİK SİGORTA C TYPE MINIATURE CIRCUIT BREAKER (MCB)	6	120	1,15602	0,00184599
MTS06-2004C	2P	6KA 2P 4A C TİPİ OTOMATİK SİGORTA C TYPE MINIATURE CIRCUIT BREAKER (MCB)	6	120	1,24002	0,00184599
MTS06-2005C	2P	6KA 2P 5A C TİPİ OTOMATİK SİGORTA C TYPE MINIATURE CIRCUIT BREAKER (MCB)	6	120	1,24002	0,00184599
MTS06-2006C	2P	6KA 2P 6A C TİPİ OTOMATİK SİGORTA C TYPE MINIATURE CIRCUIT BREAKER (MCB)	6	120	1,17402	0,00184599
MTS06-2010C	2P	6KA 2P 10A C TİPİ OTOMATİK SİGORTA C TYPE MINIATURE CIRCUIT BREAKER (MCB)	6	120	1,23402	0,00184599
MTS06-2016C	2P	6KA 2P 16A C TİPİ OTOMATİK SİGORTA C TYPE MINIATURE CIRCUIT BREAKER (MCB)	6	120	1,29402	0,00184599
MTS06-2020C	2P	6KA 2P 20A C TİPİ OTOMATİK SİGORTA C TYPE MINIATURE CIRCUIT BREAKER (MCB)	6	120	1,22202	0,00184599
MTS06-2025C	2P	6KA 2P 25A C TİPİ OTOMATİK SİGORTA C TYPE MINIATURE CIRCUIT BREAKER (MCB)	6	120	1,22202	0,00184599
MTS06-2032C	2P	6KA 2P 32A C TİPİ OTOMATİK SİGORTA C TYPE MINIATURE CIRCUIT BREAKER (MCB)	6	120	1,20402	0,00184599
MTS06-2040C	2P	6KA 2P 40A C TİPİ OTOMATİK SİGORTA C TYPE MINIATURE CIRCUIT BREAKER (MCB)	6	120	1,12602	0,00184599
MTS06-2050C	2P	6KA 2P 50A C TİPİ OTOMATİK SİGORTA C TYPE MINIATURE CIRCUIT BREAKER (MCB)	6	120	1,19802	0,00184599
MTS06-2063C	2P	6KA 2P 63A C TİPİ OTOMATİK SİGORTA C TYPE MINIATURE CIRCUIT BREAKER (MCB)	6	120	1,146	0,00184599
MTS06-3001C	3P	6KA 3P 1A C TİPİ OTOMATİK SİGORTA C TYPE MINIATURE CIRCUIT BREAKER (MCB)	4	80	1,166	0,001845988
MTS06-3002C	3P	6KA 3P 2A C TİPİ OTOMATİK SİGORTA C TYPE MINIATURE CIRCUIT BREAKER (MCB)	4	80	1,168	0,001845988
MTS06-3003C	3P	6KA 3P 3A C TİPİ OTOMATİK SİGORTA C TYPE MINIATURE CIRCUIT BREAKER (MCB)	4	80	1,17	0,001845988
MTS06-3004C	3P	6KA 3P 4A C TİPİ OTOMATİK SİGORTA C TYPE MINIATURE CIRCUIT BREAKER (MCB)	4	80	1,226	0,001845988
MTS06-3005C	3P	6KA 3P 5A C TİPİ OTOMATİK SİGORTA C TYPE MINIATURE CIRCUIT BREAKER (MCB)	4	80	1,202	0,001845988
MTS06-3006C	3P	6KA 3P 6A C TİPİ OTOMATİK SİGORTA C TYPE MINIATURE CIRCUIT BREAKER (MCB)	4	80	1,134	0,001845988
MTS06-3010C	3P	6KA 3P 10A C TİPİ OTOMATİK SİGORTA C TYPE MINIATURE CIRCUIT BREAKER (MCB)	4	80	1,174	0,001845988
MTS06-3016C	3P	6KA 3P 16A C TİPİ OTOMATİK SİGORTA C TYPE MINIATURE CIRCUIT BREAKER (MCB)	4	80	1,196	0,001845988
MTS06-3020C	3P	6KA 3P 20A C TİPİ OTOMATİK SİGORTA C TYPE MINIATURE CIRCUIT BREAKER (MCB)	4	80	1,114	0,001845988
MTS06-3025C	3P	6KA 3P 25A C TİPİ OTOMATİK SİGORTA C TYPE MINIATURE CIRCUIT BREAKER (MCB)	4	80	1,16052	0,001845988
MTS06-3032C	3P	6KA 3P 32A C TİPİ OTOMATİK SİGORTA C TYPE MINIATURE CIRCUIT BREAKER (MCB)	4	80	1,16	0,001845988
MTS06-3040C	3P	6KA 3P 40A C TİPİ OTOMATİK SİGORTA C TYPE MINIATURE CIRCUIT BREAKER (MCB)	4	80	1,16052	0,001845988
MTS06-3050C	3P	6KA 3P 50A C TİPİ OTOMATİK SİGORTA C TYPE MINIATURE CIRCUIT BREAKER (MCB)	4	80	1,168	0,001845988
MTS06-3063C	3P	6KA 3P 63A C TİPİ OTOMATİK SİGORTA C TYPE MINIATURE CIRCUIT BREAKER (MCB)	4	80	1,172	0,001845988
MTS06-4001C	4P	6KA 4P 1A C TİPİ OTOMATİK SİGORTA C TYPE MINIATURE CIRCUIT BREAKER (MCB)	3	60	1,22199	0,001845987
MTS06-4002C	4P	6KA 4P 2A C TİPİ OTOMATİK SİGORTA C TYPE MINIATURE CIRCUIT BREAKER (MCB)	3	60	1,16799	0,001845987
MTS06-4003C	4P	6KA 4P 3A C TİPİ OTOMATİK SİGORTA C TYPE MINIATURE CIRCUIT BREAKER (MCB)	3	60	1,15299	0,001845987
MTS06-4004C	4P	6KA 4P 4A C TİPİ OTOMATİK SİGORTA C TYPE MINIATURE CIRCUIT BREAKER (MCB)	3	60	1,23099	0,001845987
MTS06-4005C	4P	6KA 4P 5A C TİPİ OTOMATİK SİGORTA C TYPE MINIATURE CIRCUIT BREAKER (MCB)	3	60	1,19199	0,001845987
MTS06-4006C	4P	6KA 4P 6A C TİPİ OTOMATİK SİGORTA C TYPE MINIATURE CIRCUIT BREAKER (MCB)	3	60	1,17699	0,001845987
MTS06-4010C	4P	6KA 4P 10A C TİPİ OTOMATİK SİGORTA C TYPE MINIATURE CIRCUIT BREAKER (MCB)	3	60	1,14699	0,001845987
MTS06-4016C	4P	6KA 4P 16A C TİPİ OTOMATİK SİGORTA C TYPE MINIATURE CIRCUIT BREAKER (MCB)	3	60	1,128	0,001845987
MTS06-4020C	4P	6KA 4P 20A C TİPİ OTOMATİK SİGORTA C TYPE MINIATURE CIRCUIT BREAKER (MCB)	3	60	1,15299	0,001845987
MTS06-4025C	4P	6KA 4P 25A C TİPİ OTOMATİK SİGORTA C TYPE MINIATURE CIRCUIT BREAKER (MCB)	3	60	1,164	0,001845987
MTS06-4032C	4P	6KA 4P 32A C TİPİ OTOMATİK SİGORTA C TYPE MINIATURE CIRCUIT BREAKER (MCB)	3	60	1,1625	0,001845987
MTS06-4040C	4P	6KA 4P 40A C TİPİ OTOMATİK SİGORTA C TYPE MINIATURE CIRCUIT BREAKER (MCB)	3	60	1,164	0,001845987
MTS06-4050C	4P	6KA 4P 50A C TİPİ OTOMATİK SİGORTA C TYPE MINIATURE CIRCUIT BREAKER (MCB)	3	60	1,206	0,001845987
MTS06-4063C	4P	6KA 4P 63A C TİPİ OTOMATİK SİGORTA C TYPE MINIATURE CIRCUIT BREAKER (MCB)	3	60	1,191	0,001845987

C TİPİ OTOMATİK SİGORTALAR - 10kA C TYPE MINIATURE CIRCUIT BREAKER (MCB)

YENİ
NEW



MTS10H SERİSİ

TEKNİK BİLGİLER
TECHNICAL INFORMATION

KOD CODE	KUTUP SAYISI NO OF POLES	AÇIKLAMA DESCRIPTION	KUTU BOX	KOLİ PARCEL	KUTU AĞIRLIK BOX WEIGHT kg	KUTU HACİM BOX VOLUME m ³
MTS10-1080C	1P	10KA 1P 80A C TİPİ OTOMATİK SİGORTA C TYPE MINIATURE CIRCUIT BREAKER (MCB)	12	240	1,52196	0,001845984
MTS10-1100C	1P	10KA 1P 100A C TİPİ OTOMATİK SİGORTA C TYPE MINIATURE CIRCUIT BREAKER (MCB)	12	240	1,52196	0,001845984
MTS10-1125C	1P	10KA 1P 125A C TİPİ OTOMATİK SİGORTA C TYPE MINIATURE CIRCUIT BREAKER (MCB)	12	240	1,52196	0,001845984
MTS10-2080C	2P	10KA 2P 80A C TİPİ OTOMATİK SİGORTA C TYPE MINIATURE CIRCUIT BREAKER (MCB)	6	120	1,52802	0,00184599
MTS10-2100C	2P	10KA 2P 100A C TİPİ OTOMATİK SİGORTA C TYPE MINIATURE CIRCUIT BREAKER (MCB)	6	120	1,52802	0,00184599
MTS10-2125C	2P	10KA 2P 125A C TİPİ OTOMATİK SİGORTA C TYPE MINIATURE CIRCUIT BREAKER (MCB)	6	120	1,54002	0,00184599
MTS10-3080C	3P	10KA 3P 80A C TİPİ OTOMATİK SİGORTA C TYPE MINIATURE CIRCUIT BREAKER (MCB)	4	80	1,518	0,001845988
MTS10-3100C	3P	10KA 3P 100A C TİPİ OTOMATİK SİGORTA C TYPE MINIATURE CIRCUIT BREAKER (MCB)	4	80	1,522	0,001845988
MTS10-3125C	3P	10KA 3P 125A C TİPİ OTOMATİK SİGORTA C TYPE MINIATURE CIRCUIT BREAKER (MCB)	4	80	1,534	0,001845988
MTS10-4080C	4P	10KA 4P 80A C TİPİ OTOMATİK SİGORTA C TYPE MINIATURE CIRCUIT BREAKER (MCB)	3	60	1,50999	0,001845987
MTS10-4100C	4P	10KA 4P 100A C TİPİ OTOMATİK SİGORTA C TYPE MINIATURE CIRCUIT BREAKER (MCB)	3	60	1,50999	0,001845987
MTS10-4125C	4P	10KA 4P 125A C TİPİ OTOMATİK SİGORTA C TYPE MINIATURE CIRCUIT BREAKER (MCB)	3	60	1,52199	0,001845987

OTOMATİK SİGORTA YARDIMCI KONTAKLARI

AUTOMATIC FUSE AUXILIARY CONTACTS
TEKNİK BİLGİLER
TECHNICAL INFORMATION

KOD CODE	AÇIKLAMA DESCRIPTION	KUTU BOX	KOLİ PARCEL	KUTU AĞIRLIK BOX WEIGHT kg	KUTU HACİM BOX VOLUME m ³
MTSAUX-AC12	OTOMATİK SİGORTA YARDIMCI KONTAK 12VAC AUTOMATIC FUSE AUXILIARY CONTACTS	10	396	0,3535	0,00086584

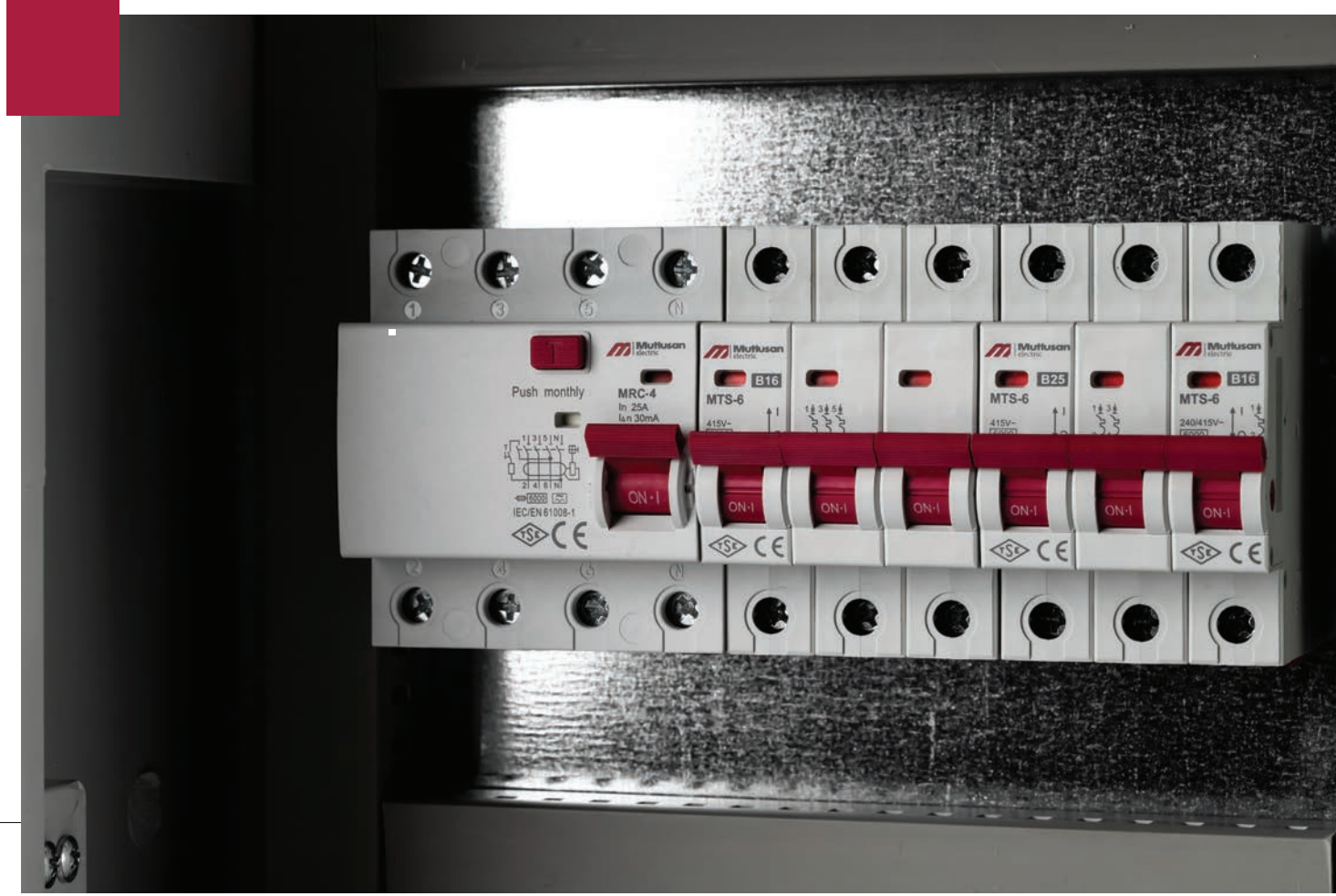

FAZ+NÖTR SİGORTA

MINIATURE CIRCUIT BREAKER PHASE+NEUTRAL
(DPN MCB)

Tek fazlı elektrik devrelerinde kullanılan bu tür minyatür devre kesiciler aşırı akım ve kısa devre durumunda hem fazı hem de nötrü koruma altına alırlar.

Circuit breakers of this type used in single-phase electrical circuits protect both phase and neutral in case of overcurrent and short circuit.



YENİ
NEW

- Aşırı akım ve kısa devre durumlarında devreyi güvenli bir şekilde keserler.
- Otomatik sigorta faz+nötr devre kesiciler genellikle konut ve hafif ticari alanlarda, özellikle de faz ve nötr hattının birlikte korunması gereken durumlarda tercih edilir.
- Kompakt tasarımı kolay kurulum sağlarken, hızlı tepki süresi akım ve kısa devre risklerine karşı etkin koruma yapar.
- Aşırı akım/kısa devre koruması yangın ve elektrik çarpması riskini azaltır.
- They safely break the circuit in cases of overcurrent and short circuit.
- DPN MCB phase+neutral circuit breakers are generally preferred in residential and light commercial areas, especially in cases where the phase and neutral lines must be protected together.
- While its compact design provides easy installation, its fast response time provides effective protection against current and short circuit risks.
- Overcurrent/short circuit protection reduces the risk of fire and electric shock.

MTS04LN SERİSİ

TEKNİK BİLGİLER TECHNICAL INFORMATION

KOD CODE	KUTUP SAYISI NO OF POLES	AÇIKLAMA DESCRIPTION	KUTU BOX	KOLİ PARCEL	KUTU AĞIRLIK BOX WEIGHT kg	KUTU HACİM BOX VOLUME m ³
MTS04-106CN	1P + N	4.5KA 1P+N 6A OTOMATİK SİGORTA MINIATURE CIRCUIT BREAKER	12	240	1,17504	0,0017487
MTS04-110CN	1P + N	4.5KA 1P+N 10A OTOMATİK SİGORTA MINIATURE CIRCUIT BREAKER	12	240	1,17504	0,0017487
MTS04-116CN	1P + N	4.5KA 1P+N 16A OTOMATİK SİGORTA MINIATURE CIRCUIT BREAKER	12	240	1,17504	0,0017487
MTS04-120CN	1P + N	4.5KA 1P+N 20A OTOMATİK SİGORTA MINIATURE CIRCUIT BREAKER	12	240	1,17504	0,0017487
MTS04-125CN	1P + N	4.5KA 1P+N 25A OTOMATİK SİGORTA MINIATURE CIRCUIT BREAKER	12	240	1,17504	0,0017487
MTS04-132CN	1P + N	4.5KA 1P+N 32A OTOMATİK SİGORTA MINIATURE CIRCUIT BREAKER	12	240	1,17504	0,0017487
MTS04-140CN	1P + N	4.5KA 1P+N 40A OTOMATİK SİGORTA MINIATURE CIRCUIT BREAKER	12	240	1,17504	0,0017487

**"Kaçak Akımda Güvenlik,
Devrede Güvence."**
"Security in Leakage,
Security in Circuit Current."



Kaçak Akım Devre Koruma Residual Current Circuit Breaker (RCCB)

Elektrik devrelerinde insanları elektrik çarpmasına karşı korumak için tasarlanmış bir güvenlik cihazıdır. Devredeki faz ve nötr akımlarını sürekli olarak izler ve bu akımlar arasında bir dengesizlik (kaçak akım) tespit ettiğinde, elektrik akışını otomatik olarak keserek devreyi güvenli bir hale getirir. elektrik çarpmalarının yanı sıra elektrik yangınlarının önlenmesine de yardımcı olur. AC ve A tipi olmak üzere 30mA-300mA aralığında 6A den 100A e kadar mevcuttur..

It is a safety device designed to protect people against electric shock in electrical circuits. It constantly monitors the phase and neutral currents in the circuit, and when it detects an imbalance (leakage current) between these currents, it automatically cuts off the electrical flow and makes the circuit safe. It helps prevent electrical fires as well as electric shocks. It is available in the range of 30mA-300mA, from 6A to 100A, including AC and A type.

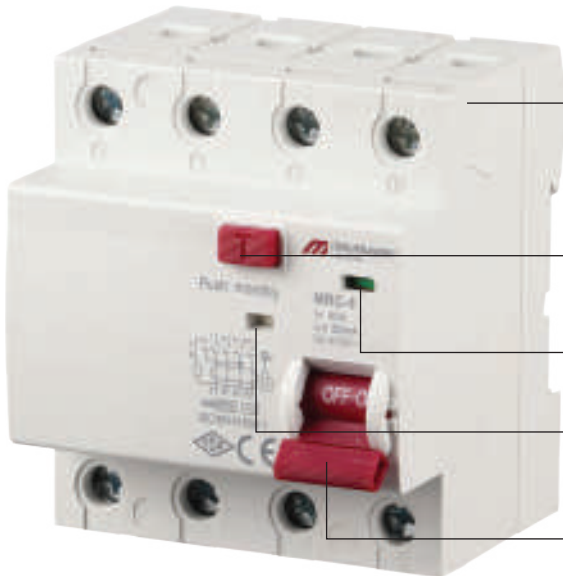

Yüksek kaliteli, yanmaz,
960 C polyamid 66 malzeme
The high quality unflam- mable,
960 C polyamide 66 material

Test Butonu
Test button

Kontakt Durumu Göstergesi
Contact position indicator

Gösterge
Trip indicator

Ergonomik Kurma Kolu
Ergonomic On/Off Lever

Çift İndikatör (Eğer cihaz, kaçak akım nedeniyle trip ettiyse test butonunun altındaki indikatör kırmızıya dönmektedir. Bu şekilde hattın kaçak nedeniyle mi yoksa el ile mi şalterin indirildiği anlaşıl- maktadır.

Double Indicator (If the device has tripped due to leakage current, the indicator under the test button turns red. In this way, it is understood whether the line is due to leakage or whether the switch is turned off manually.

KAÇAK AKIM DEVRE KORUMA

RESIDUAL CURRENT CIRCUIT BREAKER (RCCB)

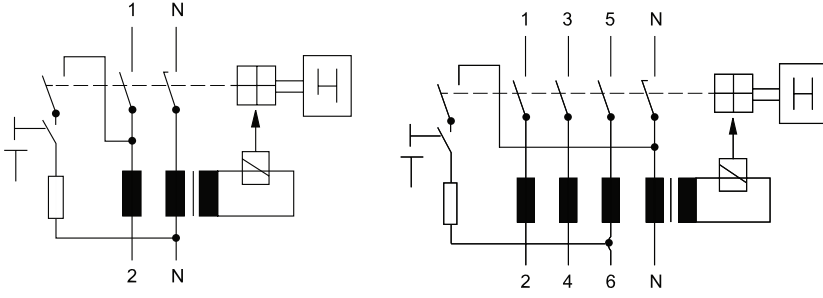

BOYUTLAR DIMENSIONS

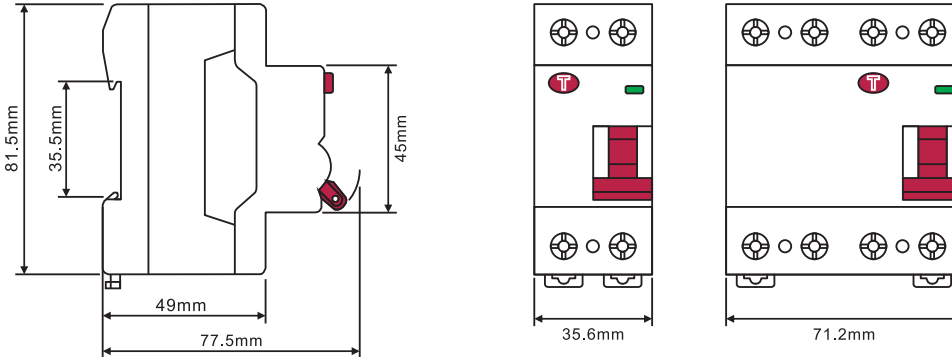

TEKNİK ÖZELLİKLER TECHNICAL SPECIFICATIONS

TİP TYPE			MRC-2/AC	MRC-4/AC
KUTUP SAYISI NUMBER OF POLES			2	4
NOMİNAL AKIM NOMINAL CURRENT	I_n	A	16,20, 25, 32, 40, 50, 63, 80, 100	16,20, 25, 32, 40, 50, 63, 80, 100
NOMİNAL ATIK AKIM NOMINAL RESIDUE CURRENT	I_{Δ}	mA	10, 30, 100, 300	10, 30, 100, 300
NOMİNAL FREKANS NOMINAL FREQUENCY		Hz	50-60	50-60
TİP TYPE			AC	AC
AÇMA ÜNİTESİ TRIP UNIT			ELEKTRO-MEKANİK	ELEKTRO-MEKANİK
ÇALIŞMA KARAKTERİSTİĞİ OPERATING CHARACTERISTICS			GENEL	GENEL
NOMİNAL ÇALIŞMA GERİLİMİ NOMINAL OPERATING VOLTAGE	U_e	(AC)V	230	400
NOMİNAL İZOLASYON GERİLİMİ NOMINAL INSULATION VOLTAGE	U_i	V	500	500
NOMİNAL DARBE DAYANIM GERİLİMİ NOMINAL IMPULSE WITHSTAND VOLTAGE	U_{imp}	kV	6	6
SİGORTALI NOMİNAL KISA DEVRE DAYANIM AKIMI ($I_{nc}/I_{\Delta c}$) NOMINAL FUSED SHORT CIRCUIT WITHSTAND CURRENT ($I_{nc}/I_{\Delta c}$)		kA	6	6
ELEKTRİKSEL ÖMÜR ELECTRICAL LIFE	op.	(230V)	6000	6000
MEKANİK ÖMÜR MECHANICAL LIFE	op.		20000	20000
KORUMA DERECESESİ PROTECTION DEGREE			IP20	IP20
ORTAM ÇALIŞMA SICAKLIĞI AMBIENT OPERATING TEMPERATURE		°C	-25 to +60	-25 to +60
MAKS. DEPOLAMA SICAKLIĞI MAX. STORAGE TEMPERATURE		°C	-40 to +70	-40 to +70
BOYUTLAR DIMENSIONS	Genişlik Width	mm	35	70
	Uzunluk Length	mm	80	80
RENK COLOR			RAL7035	RAL7035
MONTAJ TİPİ (EN60715) MOUNTING TYPE (EN60715)			35mm DIN rayı	35mm DIN rayı
MİN.MAKS. BAĞLANTI BÖLÜMÜ MIN.MAX. CONNECTION SECTION		mm ²	2.5...25	2.5...25

KAÇAK AKIM DEVRE KORUMA

RESIDUAL CURRENT CIRCUIT BREAKER (RCCB)

MRC06 SERİSİ

TEKNİK BİLGİLER TECHNICAL INFORMATION



KOD CODE	KUTUP SAYISI NO OF POLES	AÇIKLAMA DESCRIPTION	KUTU BOX	KOLİ PARCEL	KUTU AĞIRLIK BOX WEIGHT kg	KUTU HACİM BOX VOLUME m ³
MRC06-201016	2P	6KA AC 10MA 16A KAÇAK AKIM KORUMA RESIDUAL CURRENT CIRCUIT BREAKER	1	100	0,195	0,000343403
MRC06-201025	2P	6KA AC 10MA 25A KAÇAK AKIM KORUMA RESIDUAL CURRENT CIRCUIT BREAKER	1	100	0,195	0,000343403
MRC06-203016	2P	6KA AC 30MA 16A KAÇAK AKIM KORUMA RESIDUAL CURRENT CIRCUIT BREAKER	1	100	0,195	0,000343403
MRC06-203020	2P	6KA AC 30MA 20A KAÇAK AKIM KORUMA RESIDUAL CURRENT CIRCUIT BREAKER	1	100	0,195	0,000343403
MRC06-203025	2P	6KA AC 30MA 25A KAÇAK AKIM KORUMA RESIDUAL CURRENT CIRCUIT BREAKER	1	100	0,195	0,000343403
MRC06-203032	2P	6KA AC 30MA 32A KAÇAK AKIM KORUMA RESIDUAL CURRENT CIRCUIT BREAKER	1	100	0,195	0,000343403
MRC06-203040	2P	6KA AC 30MA 40A KAÇAK AKIM KORUMA RESIDUAL CURRENT CIRCUIT BREAKER	1	100	0,195	0,000343403
MRC06-203050	2P	6KA AC 30MA 50A KAÇAK AKIM KORUMA RESIDUAL CURRENT CIRCUIT BREAKER	1	100	0,215	0,000343403
MRC06-203063	2P	6KA AC 30MA 63A KAÇAK AKIM KORUMA RESIDUAL CURRENT CIRCUIT BREAKER	1	100	0,215	0,000343403
MRC06-203080	2P	6KA AC 30MA 80A KAÇAK AKIM KORUMA RESIDUAL CURRENT CIRCUIT BREAKER	1	100	0,215	0,000343403
MRC06-2030100	2P	6KA AC 30MA 100A KAÇAK AKIM KORUMA RESIDUAL CURRENT CIRCUIT BREAKER	1	100	0,215	0,000343403
MRC06-210016	2P	6KA AC 100MA 16A KAÇAK AKIM KORUMA RESIDUAL CURRENT CIRCUIT BREAKER	1	100	0,227	0,000343403
MRC06-210020	2P	6KA AC 100MA 20A KAÇAK AKIM KORUMA RESIDUAL CURRENT CIRCUIT BREAKER	1	100	0,227	0,000343403
MRC06-210025	2P	6KA AC 100MA 25A KAÇAK AKIM KORUMA RESIDUAL CURRENT CIRCUIT BREAKER	1	100	0,227	0,000343403
MRC06-210032	2P	6KA AC 100MA 32A KAÇAK AKIM KORUMA RESIDUAL CURRENT CIRCUIT BREAKER	1	100	0,227	0,000343403
MRC06-210040	2P	6KA AC 100MA 40A KAÇAK AKIM KORUMA RESIDUAL CURRENT CIRCUIT BREAKER	1	100	0,227	0,000343403
MRC06-210050	2P	6KA AC 100MA 50A KAÇAK AKIM KORUMA RESIDUAL CURRENT CIRCUIT BREAKER	1	100	0,227	0,000343403
MRC06-210063	2P	6KA AC 100MA 63A KAÇAK AKIM KORUMA RESIDUAL CURRENT CIRCUIT BREAKER	1	100	0,227	0,000343403
MRC06-210080	2P	6KA AC 100MA 80A KAÇAK AKIM KORUMA RESIDUAL CURRENT CIRCUIT BREAKER	1	100	0,227	0,000343403
MRC06-2100100	2P	6KA AC 100MA 100A KAÇAK AKIM KORUMA RESIDUAL CURRENT CIRCUIT BREAKER	1	100	0,227	0,000343403
MRC06-230016	2P	6KA AC 300MA 16A KAÇAK AKIM KORUMA RESIDUAL CURRENT CIRCUIT BREAKER	1	100	0,227	0,000343403
MRC06-230020	2P	6KA AC 300MA 20A KAÇAK AKIM KORUMA RESIDUAL CURRENT CIRCUIT BREAKER	1	100	0,227	0,000343403
MRC06-230025	2P	6KA AC 300MA 25A KAÇAK AKIM KORUMA RESIDUAL CURRENT CIRCUIT BREAKER	1	100	0,227	0,000343403
MRC06-230032	2P	6KA AC 300MA 32A KAÇAK AKIM KORUMA RESIDUAL CURRENT CIRCUIT BREAKER	1	100	0,227	0,000343403
MRC06-230040	2P	6KA AC 300MA 40A KAÇAK AKIM KORUMA RESIDUAL CURRENT CIRCUIT BREAKER	1	100	0,227	0,000343403
MRC06-230050	2P	6KA AC 300MA 50A KAÇAK AKIM KORUMA RESIDUAL CURRENT CIRCUIT BREAKER	1	100	0,227	0,000343403
MRC06-230063	2P	6KA AC 300MA 63A KAÇAK AKIM KORUMA RESIDUAL CURRENT CIRCUIT BREAKER	1	100	0,227	0,000343403
MRC06-230080	2P	6KA AC 300MA 80A KAÇAK AKIM KORUMA RESIDUAL CURRENT CIRCUIT BREAKER	1	100	0,227	0,000343403
MRC06-2300100	2P	6KA AC 300MA 100A KAÇAK AKIM KORUMA RESIDUAL CURRENT CIRCUIT BREAKER	1	100	0,227	0,000343403
MRC06-403016	4P	6KA AC 30MA 16A KAÇAK AKIM KORUMA RESIDUAL CURRENT CIRCUIT BREAKER	1	50	0,227	0,000343403
MRC06-403020	4P	6KA AC 30MA 20A KAÇAK AKIM KORUMA RESIDUAL CURRENT CIRCUIT BREAKER	1	50	0,396	0,000686805
MRC06-403025	4P	6KA AC 30MA 25A KAÇAK AKIM KORUMA RESIDUAL CURRENT CIRCUIT BREAKER	1	50	0,396	0,000686805
MRC06-403032	4P	6KA AC 30MA 32A KAÇAK AKIM KORUMA RESIDUAL CURRENT CIRCUIT BREAKER	1	50	0,396	0,000686805
MRC06-403040	4P	6KA AC 30MA 40A KAÇAK AKIM KORUMA RESIDUAL CURRENT CIRCUIT BREAKER	1	50	0,396	0,000686805
MRC06-403050	4P	6KA AC 30MA 50A KAÇAK AKIM KORUMA RESIDUAL CURRENT CIRCUIT BREAKER	1	50	0,396	0,000686805
MRC06-403063	4P	6KA AC 30MA 63A KAÇAK AKIM KORUMA RESIDUAL CURRENT CIRCUIT BREAKER	1	50	0,432	0,000686805
MRC06-403080	4P	6KA AC 30MA 80A KAÇAK AKIM KORUMA RESIDUAL CURRENT CIRCUIT BREAKER	1	50	0,432	0,000686805
MRC06-4030100	4P	6KA AC 30MA 100A KAÇAK AKIM KORUMA RESIDUAL CURRENT CIRCUIT BREAKER	1	50	0,432	0,000686805
MRC06-410016	4P	6KA AC 100MA 16A KAÇAK AKIM KORUMA RESIDUAL CURRENT CIRCUIT BREAKER	1	50	0,432	0,000686805
MRC06-410020	4P	6KA AC 100MA 20A KAÇAK AKIM KORUMA RESIDUAL CURRENT CIRCUIT BREAKER	1	50	0,432	0,000686805
MRC06-410025	4P	6KA AC 100MA 25A KAÇAK AKIM KORUMA RESIDUAL CURRENT CIRCUIT BREAKER	1	50	0,432	0,000686805
MRC06-410032	4P	6KA AC 100MA 32A KAÇAK AKIM KORUMA RESIDUAL CURRENT CIRCUIT BREAKER	1	50	0,432	0,000686805
MRC06-410040	4P	6KA AC 100MA 40A KAÇAK AKIM KORUMA RESIDUAL CURRENT CIRCUIT BREAKER	1	50	0,432	0,000686805
MRC06-410050	4P	6KA AC 100MA 50A KAÇAK AKIM KORUMA RESIDUAL CURRENT CIRCUIT BREAKER	1	50	0,432	0,000686805
MRC06-410063	4P	6KA AC 100MA 63A KAÇAK AKIM KORUMA RESIDUAL CURRENT CIRCUIT BREAKER	1	50	0,432	0,000686805
MRC06-410080	4P	6KA AC 100MA 80A KAÇAK AKIM KORUMA RESIDUAL CURRENT CIRCUIT BREAKER	1	50	0,432	0,000686805
MRC06-4100100	4P	6KA AC 100MA 100A KAÇAK AKIM KORUMA RESIDUAL CURRENT CIRCUIT BREAKER	1	50	0,432	0,000686805
MRC06-430016	4P	6KA AC 300MA 16A KAÇAK AKIM KORUMA RESIDUAL CURRENT CIRCUIT BREAKER	1	50	0,373	0,000686805
MRC06-430020	4P	6KA AC 300MA 20A KAÇAK AKIM KORUMA RESIDUAL CURRENT CIRCUIT BREAKER	1	50	0,373	0,000686805
MRC06-430025	4P	6KA AC 300MA 25A KAÇAK AKIM KORUMA RESIDUAL CURRENT CIRCUIT BREAKER	1	50	0,373	0,000686805
MRC06-430032	4P	6KA AC 300MA 32A KAÇAK AKIM KORUMA RESIDUAL CURRENT CIRCUIT BREAKER	1	50	0,373	0,000686805
MRC06-430040	4P	6KA AC 300MA 40A KAÇAK AKIM KORUMA RESIDUAL CURRENT CIRCUIT BREAKER	1	50	0,373	0,000686805
MRC06-430050	4P	6KA AC 300MA 50A KAÇAK AKIM KORUMA RESIDUAL CURRENT CIRCUIT BREAKER	1	50	0,373	0,000686805
MRC06-430063	4P	6KA AC 300MA 63A KAÇAK AKIM KORUMA RESIDUAL CURRENT CIRCUIT BREAKER	1	50	0,373	0,000686805
MRC06-430080	4P	6KA AC 300MA 80A KAÇAK AKIM KORUMA RESIDUAL CURRENT CIRCUIT BREAKER	1	50	0,373	0,000686805
MRC06-4300100	4P	6KA AC 300MA 100A KAÇAK AKIM KORUMA RESIDUAL CURRENT CIRCUIT BREAKER	1	50	0,373	0,000686805

TERMİK MANYETİK ŞALTER (TMS) MOLDED CASE CIRCUIT BREAKER (MCCB)

YENİ
NEW

Sabit Tip
Fixed Type

Ayar Sahalı
Adjustable Type

Kaçak
Akım Korumalı
Leakage Type



Devre açma ve kapama yapan termik manyetik şalterler sabit, ayar sahalı ve kaçak akım korumalı olmak üzere 18kA-50kA aralığında ve 16A'den 800A'e kadar geniş Amper seçeneğiyle.

Thermal magnetic switches (MCCB) that open and close circuits are available with fixed, adjustable, and residual current protection, offering a wide range of Ampere options from 16A to 800A and short-circuit ratings between 18kA-50kA.

16 ile 800 amper arasında akım değerlerini destekleyerek çeşitli elektrik devreleri için çok yönlü koruma sağlar.

Farklı yük koşulları için optimum performans sağlamak amacıyla aşırı yük korumasının hassas şekilde özelleştirilmesine olanak tanır.

Hem termal hem de manyetik açma üniteleriyle donatılmıştır, aşırı yük ve kısa devrelere karşı kapsamlı koruma sağlar.

Zorlu ortamlara dayanacak şekilde sağlam malzemelerle üretilmiş olup, uzun servis ömrü ve sürekli performans sunar.

Designed to handle current ratings from 16 to 800 amps, providing versatile protection for various electrical circuits.

Allows precise customization of overload protection, ensuring optimal performance for different load conditions.

Equipped with both thermal and magnetic trip units, offering comprehensive protection against overloads and short circuits.

Built with robust materials to withstand harsh environments, ensuring long service life and consistent performance.

TERMİK MANYETİK ŞALTER (TMS) SABİT TİP

MOLDED CASE CIRCUIT BREAKER (MCCB)
FIXED TYPE

MTF SERİSİ

TEKNİK BİLGİLER
TECHNICAL INFORMATION



KOD CODE	KUTUP SAYISI POLES	AÇIKLAMA DESCRIPTION	KUTU BOX	KOLİ PARCEL	KUTU AĞIRLIK BOX WEIGHT kg	KUTU HACİM BOX VOLUME m3
MTF18-2040	2P	18KA 40A TERMİK MANYETİK ŞALTER MOLDED CASE CIRCUIT BREAKER FIXED TYPE	1	36	0,547	0,00086275
MTF18-2063	2P	18KA 63A TERMİK MANYETİK ŞALTER MOLDED CASE CIRCUIT BREAKER FIXED TYPE	1	36	0,611	0,00086275
MTF18-2100	2P	18KA 100A TERMİK MANYETİK ŞALTER MOLDED CASE CIRCUIT BREAKER FIXED TYPE	1	36	0,611	0,00086275
MTF18-2125	2P	18KA 125A TERMİK MANYETİK ŞALTER MOLDED CASE CIRCUIT BREAKER FIXED TYPE	1	36	0,611	0,00086275
MTF18-2160	2P	18KA 160A TERMİK MANYETİK ŞALTER MOLDED CASE CIRCUIT BREAKER FIXED TYPE	1	36	0,611	0,00086275
MTF22-3016	3P	22KA 16A TERMİK MANYETİK ŞALTER MOLDED CASE CIRCUIT BREAKER FIXED TYPE	1	24	0,829	0,001294125
MTF22-3040	3P	22KA 40A TERMİK MANYETİK ŞALTER MOLDED CASE CIRCUIT BREAKER FIXED TYPE	1	24	0,829	0,001294125
MTF22-3063	3P	22KA 63A TERMİK MANYETİK ŞALTER MOLDED CASE CIRCUIT BREAKER FIXED TYPE	1	24	0,942	0,001294125
MTF22-3100	3P	22KA 100A TERMİK MANYETİK ŞALTER MOLDED CASE CIRCUIT BREAKER FIXED TYPE	1	24	0,942	0,001294125
MTF22-3125	3P	22KA 125A TERMİK MANYETİK ŞALTER MOLDED CASE CIRCUIT BREAKER FIXED TYPE	1	24	0,942	0,001294125
MTF22-3160	3P	22KA 160A TERMİK MANYETİK ŞALTER MOLDED CASE CIRCUIT BREAKER FIXED TYPE	1	24	0,942	0,001294125
MTF25-3016	3P	25KA 16A TERMİK MANYETİK ŞALTER MOLDED CASE CIRCUIT BREAKER FIXED TYPE	1	24	0,829	0,001294125
MTF25-3025	3P	25KA 25A TERMİK MANYETİK ŞALTER MOLDED CASE CIRCUIT BREAKER FIXED TYPE	1	24	0,829	0,001294125
MTF25-3032	3P	25KA 32A TERMİK MANYETİK ŞALTER MOLDED CASE CIRCUIT BREAKER FIXED TYPE	1	24	0,829	0,001294125
MTF25-3040	3P	25KA 40A TERMİK MANYETİK ŞALTER MOLDED CASE CIRCUIT BREAKER FIXED TYPE	1	24	0,829	0,001294125
MTF25-3050	3P	25KA 50A TERMİK MANYETİK ŞALTER MOLDED CASE CIRCUIT BREAKER FIXED TYPE	1	24	0,829	0,001294125
MTF25-3063	3P	25KA 63A TERMİK MANYETİK ŞALTER MOLDED CASE CIRCUIT BREAKER FIXED TYPE	1	24	0,942	0,001294125
MTF25-3080	3P	25KA 80A TERMİK MANYETİK ŞALTER MOLDED CASE CIRCUIT BREAKER FIXED TYPE	1	24	0,942	0,001294125
MTF25-3100	3P	25KA 100A TERMİK MANYETİK ŞALTER MOLDED CASE CIRCUIT BREAKER FIXED TYPE	1	24	0,942	0,001294125
MTF25-3125	3P	25KA 125A TERMİK MANYETİK ŞALTER MOLDED CASE CIRCUIT BREAKER FIXED TYPE	1	24	0,942	0,001294125
MTF25-3160	3P	25KA 160A TERMİK MANYETİK ŞALTER MOLDED CASE CIRCUIT BREAKER FIXED TYPE	1	24	0,942	0,001294125
MTF35-3100	3P	35KA 100A TERMİK MANYETİK ŞALTER MOLDED CASE CIRCUIT BREAKER FIXED TYPE	1	16	1,25	0,002724125
MTF35-3125	3P	35KA 125A TERMİK MANYETİK ŞALTER MOLDED CASE CIRCUIT BREAKER FIXED TYPE	1	16	1,25	0,002724125
MTF35-3160	3P	35KA 160A TERMİK MANYETİK ŞALTER MOLDED CASE CIRCUIT BREAKER FIXED TYPE	1	16	1,25	0,002724125
MTF35-3200	3P	35KA 200A TERMİK MANYETİK ŞALTER MOLDED CASE CIRCUIT BREAKER FIXED TYPE	1	16	1,25	0,002724125
MTF35-3250	3P	35KA 250A TERMİK MANYETİK ŞALTER MOLDED CASE CIRCUIT BREAKER FIXED TYPE	1	16	1,25	0,002724125
MTF42-3100	3P	42KA 100A TERMİK MANYETİK ŞALTER MOLDED CASE CIRCUIT BREAKER FIXED TYPE	1	16	1,25	0,002724125
MTF42-3125	3P	42KA 125A TERMİK MANYETİK ŞALTER MOLDED CASE CIRCUIT BREAKER FIXED TYPE	1	16	1,25	0,002724125
MTF42-3160	3P	42KA 160A TERMİK MANYETİK ŞALTER MOLDED CASE CIRCUIT BREAKER FIXED TYPE	1	16	1,25	0,002724125
MTF42-3200	3P	42KA 200A TERMİK MANYETİK ŞALTER MOLDED CASE CIRCUIT BREAKER FIXED TYPE	1	16	1,25	0,002724125
MTF42-3250	3P	42KA 250A TERMİK MANYETİK ŞALTER MOLDED CASE CIRCUIT BREAKER FIXED TYPE	1	16	1,25	0,002724125
MTF50-30315	3P	50KA 315A TERMİK MANYETİK ŞALTER MOLDED CASE CIRCUIT BREAKER FIXED TYPE	1	12	1,917	0,003131333
MTF50-30400	3P	50KA 400A TERMİK MANYETİK ŞALTER MOLDED CASE CIRCUIT BREAKER FIXED TYPE	1	12	1,917	0,003131333
MTF50-30500	3P	50KA 500A TERMİK MANYETİK ŞALTER MOLDED CASE CIRCUIT BREAKER FIXED TYPE	1	12	1,917	0,003131333
MTF50-30630	3P	50KA 630A TERMİK MANYETİK ŞALTER MOLDED CASE CIRCUIT BREAKER FIXED TYPE	1	12	1,917	0,003131333
MTF50-30800	3P	50KA 800A TERMİK MANYETİK ŞALTER MOLDED CASE CIRCUIT BREAKER FIXED TYPE	1	12	1,917	0,003131333
MTF22-4016	4P	22KA 16A TERMİK MANYETİK ŞALTER MOLDED CASE CIRCUIT BREAKER FIXED TYPE	1	18	1,033	0,0017255
MTF22-4040	4P	22KA 40A TERMİK MANYETİK ŞALTER MOLDED CASE CIRCUIT BREAKER FIXED TYPE	1	18	1,033	0,0017255
MTF22-4063	4P	22KA 63A TERMİK MANYETİK ŞALTER MOLDED CASE CIRCUIT BREAKER FIXED TYPE	1	18	1,183	0,0017255
MTF22-4100	4P	22KA 100A TERMİK MANYETİK ŞALTER MOLDED CASE CIRCUIT BREAKER FIXED TYPE	1	18	1,183	0,0017255
MTF22-4125	4P	22KA 125A TERMİK MANYETİK ŞALTER MOLDED CASE CIRCUIT BREAKER FIXED TYPE	1	18	1,183	0,0017255
MTF22-4160	4P	22KA 160A TERMİK MANYETİK ŞALTER MOLDED CASE CIRCUIT BREAKER FIXED TYPE	1	18	1,183	0,0017255
MTF25-4016	4P	25KA 16A TERMİK MANYETİK ŞALTER MOLDED CASE CIRCUIT BREAKER FIXED TYPE	1	18	1,033	0,0017255
MTF25-4025	4P	25KA 25A TERMİK MANYETİK ŞALTER MOLDED CASE CIRCUIT BREAKER FIXED TYPE	1	18	1,033	0,0017255
MTF25-4032	4P	25KA 32A TERMİK MANYETİK ŞALTER MOLDED CASE CIRCUIT BREAKER FIXED TYPE	1	18	1,033	0,0017255
MTF25-4040	4P	25KA 40A TERMİK MANYETİK ŞALTER MOLDED CASE CIRCUIT BREAKER FIXED TYPE	1	18	1,033	0,0017255
MTF25-4063	4P	25KA 63A TERMİK MANYETİK ŞALTER MOLDED CASE CIRCUIT BREAKER FIXED TYPE	1	18	1,183	0,0017255
MTF25-4080	4P	25KA 80A TERMİK MANYETİK ŞALTER MOLDED CASE CIRCUIT BREAKER FIXED TYPE	1	18	1,183	0,0017255
MTF25-4100	4P	25KA 100A TERMİK MANYETİK ŞALTER MOLDED CASE CIRCUIT BREAKER FIXED TYPE	1	18	1,183	0,0017255
MTF25-4125	4P	25KA 125A TERMİK MANYETİK ŞALTER MOLDED CASE CIRCUIT BREAKER FIXED TYPE	1	18	1,183	0,0017255
MTF25-4160	4P	25KA 160A TERMİK MANYETİK ŞALTER MOLDED CASE CIRCUIT BREAKER FIXED TYPE	1	18	1,183	0,0017255
MTF35-4100	4P	35KA 100A TERMİK MANYETİK ŞALTER MOLDED CASE CIRCUIT BREAKER FIXED TYPE	1	12	1,917	0,003131333
MTF35-4125	4P	35KA 125A TERMİK MANYETİK ŞALTER MOLDED CASE CIRCUIT BREAKER FIXED TYPE	1	12	1,917	0,003131333
MTF35-4160	4P	35KA 160A TERMİK MANYETİK ŞALTER MOLDED CASE CIRCUIT BREAKER FIXED TYPE	1	12	1,917	0,003131333
MTF35-4200	4P	35KA 200A TERMİK MANYETİK ŞALTER MOLDED CASE CIRCUIT BREAKER FIXED TYPE	1	12	1,917	0,003131333
MTF35-4250	4P	35KA 250A TERMİK MANYETİK ŞALTER MOLDED CASE CIRCUIT BREAKER FIXED TYPE	1	12	1,917	0,003131333
MTF42-4100	4P	42KA 100A TERMİK MANYETİK ŞALTER MOLDED CASE CIRCUIT BREAKER FIXED TYPE	1	12	1,917	0,003131333
MTF42-4125	4P	42KA 125A TERMİK MANYETİK ŞALTER MOLDED CASE CIRCUIT BREAKER FIXED TYPE	1	12	1,917	0,003131333
MTF42-4160	4P	42KA 160A TERMİK MANYETİK ŞALTER MOLDED CASE CIRCUIT BREAKER FIXED TYPE	1	12	1,917	0,003131333
MTF42-4200	4P	42KA 200A TERMİK MANYETİK ŞALTER MOLDED CASE CIRCUIT BREAKER FIXED TYPE	1	12	1,917	0,003131333
MTF42-4250	4P	42KA 250A TERMİK MANYETİK ŞALTER MOLDED CASE CIRCUIT BREAKER FIXED TYPE	1	12	1,917	0,003131333
MTF50-40315	4P	50KA 315A TERMİK MANYETİK ŞALTER MOLDED CASE CIRCUIT BREAKER FIXED TYPE	1	12	1,917	0,003131333
MTF50-40400	4P	50KA 400A TERMİK MANYETİK ŞALTER MOLDED CASE CIRCUIT BREAKER FIXED TYPE	1	12	1,917	0,003131333
MTF50-40500	4P	50KA 500A TERMİK MANYETİK ŞALTER MOLDED CASE CIRCUIT BREAKER FIXED TYPE	1	12	1,917	0,003131333
MTF50-40630	4P	50KA 630A TERMİK MANYETİK ŞALTER MOLDED CASE CIRCUIT BREAKER FIXED TYPE	1	12	1,917	0,003131333
MTF50-40800	4P	50KA 800A TERMİK MANYETİK ŞALTER MOLDED CASE CIRCUIT BREAKER FIXED TYPE	1	12	1,917	0,003131333

TERMİK MANYETİK ŞALTER (TMŞ)

AYAR SAHALI TİP

MOLDED CASE CIRCUIT BREAKER (MCCB)
ADJUSTABLE TYPE



MTA SERİSİ

TEKNİK BİLGİLER

TECHNICAL INFORMATION

KOD CODE	KUTUP SAYISI POLES	AÇIKLAMA DESCRIPTION	TERMİK AYAR SAHASI (A) THERMAL ADJUSTMENT RANGE	KUTU BOX	KOLİ PARCEL	KUTU AĞIRLIK BOX WEIGHT kg	KUTU HACİM BOX VOLUME m3
MTA18-2040	2P	18KA 40A TERMİK MANYETİK ŞALTER MOLDED CASE CIRCUIT BREAKER ADJUSTABLE TYPE	32-40	1	36	0,547	0,00086275
MTA18-2063	2P	18KA 63A TERMİK MANYETİK ŞALTER MOLDED CASE CIRCUIT BREAKER ADJUSTABLE TYPE	50-63	1	36	0,611	0,00086275
MTA18-2100	2P	18KA 100A TERMİK MANYETİK ŞALTER MOLDED CASE CIRCUIT BREAKER ADJUSTABLE TYPE	80-100	1	36	0,611	0,00086275
MTA18-2125	2P	18KA 125A TERMİK MANYETİK ŞALTER MOLDED CASE CIRCUIT BREAKER ADJUSTABLE TYPE	100-125	1	36	0,611	0,00086275
MTA18-2160	2P	18KA 160A TERMİK MANYETİK ŞALTER MOLDED CASE CIRCUIT BREAKER ADJUSTABLE TYPE	125-160	1	36	0,611	0,00086275
MTA22-3016	3P	22KA 16A TERMİK MANYETİK ŞALTER MOLDED CASE CIRCUIT BREAKER ADJUSTABLE TYPE	12-16	1	24	0,829	0,001294125
MTA22-3040	3P	22KA 40A TERMİK MANYETİK ŞALTER MOLDED CASE CIRCUIT BREAKER ADJUSTABLE TYPE	32-40	1	24	0,829	0,001294125
MTA22-3063	3P	22KA 63A TERMİK MANYETİK ŞALTER MOLDED CASE CIRCUIT BREAKER ADJUSTABLE TYPE	50-63	1	24	0,942	0,001294125
MTA22-3100	3P	22KA 100A TERMİK MANYETİK ŞALTER MOLDED CASE CIRCUIT BREAKER ADJUSTABLE TYPE	80-100	1	24	0,942	0,001294125
MTA22-3125	3P	22KA 125A TERMİK MANYETİK ŞALTER MOLDED CASE CIRCUIT BREAKER ADJUSTABLE TYPE	100-125	1	24	0,942	0,001294125
MTA22-3160	3P	22KA 160A TERMİK MANYETİK ŞALTER MOLDED CASE CIRCUIT BREAKER ADJUSTABLE TYPE	125-160	1	24	0,942	0,001294125
MTA25-3016	3P	25KA 16A TERMİK MANYETİK ŞALTER MOLDED CASE CIRCUIT BREAKER ADJUSTABLE TYPE	12-16	1	24	0,82917	0,001294125
MTA25-3025	3P	25KA 25A TERMİK MANYETİK ŞALTER MOLDED CASE CIRCUIT BREAKER ADJUSTABLE TYPE	16-25	1	24	0,829	0,001294125
MTA25-3032	3P	25KA 32A TERMİK MANYETİK ŞALTER MOLDED CASE CIRCUIT BREAKER ADJUSTABLE TYPE	25-32	1	24	0,829	0,001294125
MTA25-3040	3P	25KA 40A TERMİK MANYETİK ŞALTER MOLDED CASE CIRCUIT BREAKER ADJUSTABLE TYPE	32-40	1	24	0,829	0,001294125
MTA25-3050	3P	25KA 50A TERMİK MANYETİK ŞALTER MOLDED CASE CIRCUIT BREAKER ADJUSTABLE TYPE	40-50	1	24	0,829	0,001294125
MTA25-3063	3P	25KA 63A TERMİK MANYETİK ŞALTER MOLDED CASE CIRCUIT BREAKER ADJUSTABLE TYPE	50-63	1	24	0,94167	0,001294125
MTA25-3080	3P	25KA 80A TERMİK MANYETİK ŞALTER MOLDED CASE CIRCUIT BREAKER ADJUSTABLE TYPE	63-80	1	24	0,942	0,001294125
MTA25-3100	3P	25KA 100A TERMİK MANYETİK ŞALTER MOLDED CASE CIRCUIT BREAKER ADJUSTABLE TYPE	80-100	1	24	0,942	0,001294125
MTA25-3125	3P	25KA 125A TERMİK MANYETİK ŞALTER MOLDED CASE CIRCUIT BREAKER ADJUSTABLE TYPE	100-125	1	24	0,942	0,001294125
MTA25-3160	3P	25KA 160A TERMİK MANYETİK ŞALTER MOLDED CASE CIRCUIT BREAKER ADJUSTABLE TYPE	125-160	1	24	0,942	0,001294125
MTA35-3100	3P	35KA 100A TERMİK MANYETİK ŞALTER MOLDED CASE CIRCUIT BREAKER ADJUSTABLE TYPE	80-100	1	16	1,25	0,002724125
MTA35-3125	3P	35KA 125A TERMİK MANYETİK ŞALTER MOLDED CASE CIRCUIT BREAKER ADJUSTABLE TYPE	100-125	1	16	1,25	0,002724125
MTA35-3160	3P	35KA 160A TERMİK MANYETİK ŞALTER MOLDED CASE CIRCUIT BREAKER ADJUSTABLE TYPE	125-160	1	16	1,25	0,002724125
MTA35-3200	3P	35KA 200A TERMİK MANYETİK ŞALTER MOLDED CASE CIRCUIT BREAKER ADJUSTABLE TYPE	160-200	1	16	1,25	0,002724125
MTA35-3250	3P	35KA 250A TERMİK MANYETİK ŞALTER MOLDED CASE CIRCUIT BREAKER ADJUSTABLE TYPE	200-250	1	16	1,25	0,002724125
MTA42-3100	3P	42KA 100A TERMİK MANYETİK ŞALTER MOLDED CASE CIRCUIT BREAKER ADJUSTABLE TYPE	80-100	1	16	1,25	0,002724125
MTA42-3125	3P	42KA 125A TERMİK MANYETİK ŞALTER MOLDED CASE CIRCUIT BREAKER ADJUSTABLE TYPE	100-125	1	16	1,25	0,002724125
MTA42-3160	3P	42KA 160A TERMİK MANYETİK ŞALTER MOLDED CASE CIRCUIT BREAKER ADJUSTABLE TYPE	125-160	1	16	1,25	0,002724125
MTA42-3200	3P	42KA 200A TERMİK MANYETİK ŞALTER MOLDED CASE CIRCUIT BREAKER ADJUSTABLE TYPE	160-200	1	16	1,25	0,002724125
MTA42-3250	3P	42KA 250A TERMİK MANYETİK ŞALTER MOLDED CASE CIRCUIT BREAKER ADJUSTABLE TYPE	200-250	1	16	1,25	0,002724125
MTA50-30315	3P	50KA 315A TERMİK MANYETİK ŞALTER MOLDED CASE CIRCUIT BREAKER ADJUSTABLE TYPE	250-315	1	4	5,726	0,014112866
MTA50-30400	3P	50KA 400A TERMİK MANYETİK ŞALTER MOLDED CASE CIRCUIT BREAKER ADJUSTABLE TYPE	315-400	1	4	5,726	0,014112866
MTA50-30630	3P	50KA 630A TERMİK MANYETİK ŞALTER MOLDED CASE CIRCUIT BREAKER ADJUSTABLE TYPE	500-630	1	2	7,571	0,016883285
MTA50-30800	3P	50KA 800A TERMİK MANYETİK ŞALTER MOLDED CASE CIRCUIT BREAKER ADJUSTABLE TYPE	630-800	1	2	8,877	0,0185024
MTA22-4016	4P	22KA 16A TERMİK MANYETİK ŞALTER MOLDED CASE CIRCUIT BREAKER ADJUSTABLE TYPE	12-16	1	18	1,033	0,0017255
MTA22-4040	4P	22KA 40A TERMİK MANYETİK ŞALTER MOLDED CASE CIRCUIT BREAKER ADJUSTABLE TYPE	32-40	1	18	1,033	0,0017255
MTA22-4063	4P	22KA 63A TERMİK MANYETİK ŞALTER MOLDED CASE CIRCUIT BREAKER ADJUSTABLE TYPE	50-63	1	18	1,183	0,0017255
MTA22-4100	4P	22KA 100A TERMİK MANYETİK ŞALTER MOLDED CASE CIRCUIT BREAKER ADJUSTABLE TYPE	80-100	1	18	1,183	0,0017255
MTA22-4125	4P	22KA 125A TERMİK MANYETİK ŞALTER MOLDED CASE CIRCUIT BREAKER ADJUSTABLE TYPE	100-125	1	18	1,183	0,0017255
MTA22-4160	4P	22KA 160A TERMİK MANYETİK ŞALTER MOLDED CASE CIRCUIT BREAKER ADJUSTABLE TYPE	125-160	1	18	1,18333	0,0017255
MTA25-4016	4P	25KA 16A TERMİK MANYETİK ŞALTER MOLDED CASE CIRCUIT BREAKER ADJUSTABLE TYPE	12-16	1	18	1,03333	0,0017255
MTA25-4025	4P	25KA 25A TERMİK MANYETİK ŞALTER MOLDED CASE CIRCUIT BREAKER ADJUSTABLE TYPE	16-25	1	18	1,033	0,0017255
MTA25-4032	4P	25KA 32A TERMİK MANYETİK ŞALTER MOLDED CASE CIRCUIT BREAKER ADJUSTABLE TYPE	25-32	1	18	1,033	0,0017255
MTA25-4040	4P	25KA 40A TERMİK MANYETİK ŞALTER MOLDED CASE CIRCUIT BREAKER ADJUSTABLE TYPE	32-40	1	18	1,03333	0,0017255
MTA25-4063	4P	25KA 63A TERMİK MANYETİK ŞALTER MOLDED CASE CIRCUIT BREAKER ADJUSTABLE TYPE	50-63	1	18	1,18333	0,0017255
MTA25-4080	4P	25KA 80A TERMİK MANYETİK ŞALTER MOLDED CASE CIRCUIT BREAKER ADJUSTABLE TYPE	63-80	1	18	1,183	0,0017255
MTA25-4100	4P	25KA 100A TERMİK MANYETİK ŞALTER MOLDED CASE CIRCUIT BREAKER ADJUSTABLE TYPE	80-100	1	18	1,18333	0,0017255
MTA25-4125	4P	25KA 125A TERMİK MANYETİK ŞALTER MOLDED CASE CIRCUIT BREAKER ADJUSTABLE TYPE	100-125	1	18	1,18333	0,0017255
MTA25-4160	4P	25KA 160A TERMİK MANYETİK ŞALTER MOLDED CASE CIRCUIT BREAKER ADJUSTABLE TYPE	125-160	1	18	1,18333	0,0017255
MTA35-4100	4P	35KA 100A TERMİK MANYETİK ŞALTER MOLDED CASE CIRCUIT BREAKER ADJUSTABLE TYPE	80-100	1	12	1,91667	0,003131333
MTA35-4125	4P	35KA 125A TERMİK MANYETİK ŞALTER MOLDED CASE CIRCUIT BREAKER ADJUSTABLE TYPE	100-125	1	12	1,91667	0,003131333
MTA35-4160	4P	35KA 160A TERMİK MANYETİK ŞALTER MOLDED CASE CIRCUIT BREAKER ADJUSTABLE TYPE	125-160	1	12	1,91667	0,003131333
MTA35-4200	4P	35KA 200A TERMİK MANYETİK ŞALTER MOLDED CASE CIRCUIT BREAKER ADJUSTABLE TYPE	160-200	1	12	1,91667	0,003131333
MTA35-4250	4P	35KA 250A TERMİK MANYETİK ŞALTER MOLDED CASE CIRCUIT BREAKER ADJUSTABLE TYPE	200-250	1	12	1,91667	0,003131333
MTA42-4100	4P	42KA 100A TERMİK MANYETİK ŞALTER MOLDED CASE CIRCUIT BREAKER ADJUSTABLE TYPE	80-100	1	12	1,91667	0,003131333
MTA42-4125	4P	42KA 125A TERMİK MANYETİK ŞALTER MOLDED CASE CIRCUIT BREAKER ADJUSTABLE TYPE	100-125	1	12	1,91667	0,003131333
MTA42-4160	4P	42KA 160A TERMİK MANYETİK ŞALTER MOLDED CASE CIRCUIT BREAKER ADJUSTABLE TYPE	125-160	1	12	1,91667	0,003131333
MTA42-4200	4P	42KA 200A TERMİK MANYETİK ŞALTER MOLDED CASE CIRCUIT BREAKER ADJUSTABLE TYPE	160-200	1	12	1,91667	0,003131333
MTA42-4250	4P	42KA 250A TERMİK MANYETİK ŞALTER MOLDED CASE CIRCUIT BREAKER ADJUSTABLE TYPE	200-250	1	12	1,91667	0,003131333
MTA50-40315	4P	50KA 315A TERMİK MANYETİK ŞALTER MOLDED CASE CIRCUIT BREAKER ADJUSTABLE TYPE	250-315	1	3	7,325	0,01543333
MTA50-40400	4P	50KA 400A TERMİK MANYETİK ŞALTER MOLDED CASE CIRCUIT BREAKER ADJUSTABLE TYPE	315-400	1	3	7,325	0,01543333
MTA50-40630	4P	50KA 630A TERMİK MANYETİK ŞALTER MOLDED CASE CIRCUIT BREAKER ADJUSTABLE TYPE	500-630	1	2	9,766	0,0185888
MTA50-40800	4P	50KA 800A TERMİK MANYETİK ŞALTER MOLDED CASE CIRCUIT BREAKER ADJUSTABLE TYPE	630-800	1	2	11,394	0,0232064

TERMİK MANYETİK ŞALTER (TMS)
KAÇAK AKIM KORUMALI TİP
 MOLDED CASE CIRCUIT BREAKER (MCCB)
 LEAKAGE TYPE



MTL SERİSİ

TEKNİK BİLGİLER
 TECHNICAL INFORMATION

KOD CODE	KUTUP SAYISI POLES	AÇIKLAMA DESCRIPTION	KAPASİTE THERMAL ADJUSTMENT RANGE (mA)	KUTU BOX	KOLİ PARCEL	KUTU AĞIRLIK BOX WEIGHT kg	KUTU HACİM BOX VOLUME m3
MTL18-2025	2P	18KA 25A TERMİK MANYETİK ŞALTER MOLDED CASE CIRCUIT BREAKER LEAKAGE TYPE	30-300-500	1	36	0,547	0,00086275
MTL18-2040	2P	18KA 40A TERMİK MANYETİK ŞALTER MOLDED CASE CIRCUIT BREAKER LEAKAGE TYPE	30-300-500	1	36	0,54722	0,00086275
MTL18-2063	2P	18KA 63A TERMİK MANYETİK ŞALTER MOLDED CASE CIRCUIT BREAKER LEAKAGE TYPE	30-300-500	1	36	0,6111	0,00086275
MTL18-2100	2P	18KA 100A TERMİK MANYETİK ŞALTER MOLDED CASE CIRCUIT BREAKER LEAKAGE TYPE	30-300-500	1	36	0,6111	0,00086275
MTL18-2125	2P	18KA 125A TERMİK MANYETİK ŞALTER MOLDED CASE CIRCUIT BREAKER LEAKAGE TYPE	30-300-500	1	36	0,6111	0,00086275
MTL22-3016	3P	22KA 16A TERMİK MANYETİK ŞALTER MOLDED CASE CIRCUIT BREAKER LEAKAGE TYPE	30-300-500	1	20	1	0,0026676
MTL22-3040	3P	22KA 40A TERMİK MANYETİK ŞALTER MOLDED CASE CIRCUIT BREAKER LEAKAGE TYPE	30-300-500	1	20	1	0,0026676
MTL22-3063	3P	22KA 63A TERMİK MANYETİK ŞALTER MOLDED CASE CIRCUIT BREAKER LEAKAGE TYPE	30-300-500	1	20	1	0,0026676
MTL22-3100	3P	22KA 100A TERMİK MANYETİK ŞALTER MOLDED CASE CIRCUIT BREAKER LEAKAGE TYPE	30-300-500	1	20	1	0,0026676
MTL22-3125	3P	22KA 125A TERMİK MANYETİK ŞALTER MOLDED CASE CIRCUIT BREAKER LEAKAGE TYPE	30-300-500	1	20	1	0,0026676
MTL25-3016	3P	25KA 16A TERMİK MANYETİK ŞALTER MOLDED CASE CIRCUIT BREAKER LEAKAGE TYPE	30-300-500	1	20	1	0,0026676
MTL25-3025	3P	25KA 25A TERMİK MANYETİK ŞALTER MOLDED CASE CIRCUIT BREAKER LEAKAGE TYPE	30-300-500	1	20	1	0,0026676
MTL25-3032	3P	25KA 32A TERMİK MANYETİK ŞALTER MOLDED CASE CIRCUIT BREAKER LEAKAGE TYPE	30-300-500	1	20	1	0,0026676
MTL25-3040	3P	25KA 40A TERMİK MANYETİK ŞALTER MOLDED CASE CIRCUIT BREAKER LEAKAGE TYPE	30-300-500	1	20	1	0,0026676
MTL25-3050	3P	25KA 50A TERMİK MANYETİK ŞALTER MOLDED CASE CIRCUIT BREAKER LEAKAGE TYPE	30-300-500	1	20	1	0,0026676
MTL25-3063	3P	25KA 63A TERMİK MANYETİK ŞALTER MOLDED CASE CIRCUIT BREAKER LEAKAGE TYPE	30-300-500	1	20	1	0,0026676
MTL25-3080	3P	25KA 80A TERMİK MANYETİK ŞALTER MOLDED CASE CIRCUIT BREAKER LEAKAGE TYPE	30-300-500	1	20	1	0,0026676
MTL25-3100	3P	25KA 100A TERMİK MANYETİK ŞALTER MOLDED CASE CIRCUIT BREAKER LEAKAGE TYPE	30-300-500	1	20	1	0,0026676
MTL25-3125	3P	25KA 125A TERMİK MANYETİK ŞALTER MOLDED CASE CIRCUIT BREAKER LEAKAGE TYPE	30-300-500	1	20	1	0,0026676
MTL35-3100	3P	35KA 100A TERMİK MANYETİK ŞALTER MOLDED CASE CIRCUIT BREAKER LEAKAGE TYPE	30-300-500	1	10	1,73	0,0042809
MTL35-3125	3P	35KA 125A TERMİK MANYETİK ŞALTER MOLDED CASE CIRCUIT BREAKER LEAKAGE TYPE	30-300-500	1	10	1,73	0,0042809
MTL35-3160	3P	35KA 160A TERMİK MANYETİK ŞALTER MOLDED CASE CIRCUIT BREAKER LEAKAGE TYPE	30-300-500	1	10	1,73	0,0042809
MTL35-3200	3P	35KA 200A TERMİK MANYETİK ŞALTER MOLDED CASE CIRCUIT BREAKER LEAKAGE TYPE	30-300-500	1	10	1,73	0,0042809
MTL35-3250	3P	35KA 250A TERMİK MANYETİK ŞALTER MOLDED CASE CIRCUIT BREAKER LEAKAGE TYPE	30-300-500	1	10	1,73	0,0042809
MTL35-3315	3P	35KA 315A TERMİK MANYETİK ŞALTER MOLDED CASE CIRCUIT BREAKER LEAKAGE TYPE	30-300-500	1	10	1,73	0,0042809
MTL35-3400	3P	35KA 400A TERMİK MANYETİK ŞALTER MOLDED CASE CIRCUIT BREAKER LEAKAGE TYPE	30-300-500	1	10	1,73	0,0042809
MTL35-3630	3P	35KA 630A TERMİK MANYETİK ŞALTER MOLDED CASE CIRCUIT BREAKER LEAKAGE TYPE	30-300-500	1	10	1,73	0,0042809
MTL42-3100	3P	42KA 100A TERMİK MANYETİK ŞALTER MOLDED CASE CIRCUIT BREAKER LEAKAGE TYPE	30-300-500	1	10	1,73	0,0042809
MTL42-3125	3P	42KA 125A TERMİK MANYETİK ŞALTER MOLDED CASE CIRCUIT BREAKER LEAKAGE TYPE	30-300-500	1	10	1,73	0,0042809
MTL42-3160	3P	42KA 160A TERMİK MANYETİK ŞALTER MOLDED CASE CIRCUIT BREAKER LEAKAGE TYPE	30-300-500	1	10	1,73	0,0042809
MTL42-3200	3P	42KA 200A TERMİK MANYETİK ŞALTER MOLDED CASE CIRCUIT BREAKER LEAKAGE TYPE	30-300-500	1	10	1,73	0,0042809
MTL42-3250	3P	42KA 250A TERMİK MANYETİK ŞALTER MOLDED CASE CIRCUIT BREAKER LEAKAGE TYPE	30-300-500	1	10	1,73	0,0042809
MTL50-30315	3P	50KA 315A TERMİK MANYETİK ŞALTER MOLDED CASE CIRCUIT BREAKER LEAKAGE TYPE	100-300-500	1	8	2,213	0,005351125
MTL50-30400	3P	50KA 400A TERMİK MANYETİK ŞALTER MOLDED CASE CIRCUIT BREAKER LEAKAGE TYPE	100-300-500	1	8	2,213	0,005351125
MTL50-30630	3P	50KA 630A TERMİK MANYETİK ŞALTER MOLDED CASE CIRCUIT BREAKER LEAKAGE TYPE	100-300-500	1	8	2,213	0,005351125
MTL50-30800	3P	50KA 800A TERMİK MANYETİK ŞALTER MOLDED CASE CIRCUIT BREAKER LEAKAGE TYPE	100-300-500	1	10	1,73	0,0042809
MTL22-4016	4P	22KA 16A TERMİK MANYETİK ŞALTER MOLDED CASE CIRCUIT BREAKER LEAKAGE TYPE	30-300-500	1	16	1,188	0,0033345
MTL22-4025	4P	22KA 25A TERMİK MANYETİK ŞALTER MOLDED CASE CIRCUIT BREAKER LEAKAGE TYPE	30-300-500	1	16	1,188	0,0033345
MTL22-4040	4P	22KA 40A TERMİK MANYETİK ŞALTER MOLDED CASE CIRCUIT BREAKER LEAKAGE TYPE	30-300-500	1	16	1,1875	0,0033345
MTL22-4063	4P	22KA 63A TERMİK MANYETİK ŞALTER MOLDED CASE CIRCUIT BREAKER LEAKAGE TYPE	30-300-500	1	16	1,3125	0,0033345
MTL22-4100	4P	22KA 100A TERMİK MANYETİK ŞALTER MOLDED CASE CIRCUIT BREAKER LEAKAGE TYPE	30-300-500	1	16	1,313	0,0033345
MTL22-4125	4P	22KA 125A TERMİK MANYETİK ŞALTER MOLDED CASE CIRCUIT BREAKER LEAKAGE TYPE	30-300-500	1	16	1,313	0,0033345
MTL25-4016	4P	25KA 16A TERMİK MANYETİK ŞALTER MOLDED CASE CIRCUIT BREAKER LEAKAGE TYPE	30-300-500	1	16	1,1875	0,0033345
MTL25-4025	4P	25KA 25A TERMİK MANYETİK ŞALTER MOLDED CASE CIRCUIT BREAKER LEAKAGE TYPE	30-300-500	1	16	1,188	0,0033345
MTL25-4032	4P	25KA 32A TERMİK MANYETİK ŞALTER MOLDED CASE CIRCUIT BREAKER LEAKAGE TYPE	30-300-500	1	16	1,188	0,0033345
MTL25-4040	4P	25KA 40A TERMİK MANYETİK ŞALTER MOLDED CASE CIRCUIT BREAKER LEAKAGE TYPE	30-300-500	1	16	1,1875	0,0033345
MTL25-4050	4P	25KA 50A TERMİK MANYETİK ŞALTER MOLDED CASE CIRCUIT BREAKER LEAKAGE TYPE	30-300-500	1	16	1,188	0,0033345
MTL25-4063	4P	25KA 63A TERMİK MANYETİK ŞALTER MOLDED CASE CIRCUIT BREAKER LEAKAGE TYPE	30-300-500	1	16	1,3125	0,0033345
MTL25-4080	4P	25KA 80A TERMİK MANYETİK ŞALTER MOLDED CASE CIRCUIT BREAKER LEAKAGE TYPE	30-300-500	1	16	1,313	0,0033345
MTL25-4100	4P	25KA 100A TERMİK MANYETİK ŞALTER MOLDED CASE CIRCUIT BREAKER LEAKAGE TYPE	30-300-500	1	16	1,3125	0,0033345
MTL25-4125	4P	25KA 125A TERMİK MANYETİK ŞALTER MOLDED CASE CIRCUIT BREAKER LEAKAGE TYPE	30-300-500	1	16	1,3125	0,0033345
MTL35-4100	4P	35KA 100A TERMİK MANYETİK ŞALTER MOLDED CASE CIRCUIT BREAKER LEAKAGE TYPE	30-300-500	1	8	2,2125	0,005351125
MTL35-4125	4P	35KA 125A TERMİK MANYETİK ŞALTER MOLDED CASE CIRCUIT BREAKER LEAKAGE TYPE	30-300-500	1	8	2,2125	0,005351125
MTL35-4160	4P	35KA 160A TERMİK MANYETİK ŞALTER MOLDED CASE CIRCUIT BREAKER LEAKAGE TYPE	30-300-500	1	8	2,2125	0,005351125
MTL35-4200	4P	35KA 200A TERMİK MANYETİK ŞALTER MOLDED CASE CIRCUIT BREAKER LEAKAGE TYPE	30-300-500	1	8	2,2125	0,005351125
MTL35-4250	4P	35KA 250A TERMİK MANYETİK ŞALTER MOLDED CASE CIRCUIT BREAKER LEAKAGE TYPE	30-300-500	1	8	2,2125	0,005351125
MTL42-4100	4P	42KA 100A TERMİK MANYETİK ŞALTER MOLDED CASE CIRCUIT BREAKER LEAKAGE TYPE	30-300-500	1	8	2,2125	0,005351125
MTL42-4125	4P	42KA 125A TERMİK MANYETİK ŞALTER MOLDED CASE CIRCUIT BREAKER LEAKAGE TYPE	30-300-500	1	8	2,2125	0,005351125
MTL42-4160	4P	42KA 160A TERMİK MANYETİK ŞALTER MOLDED CASE CIRCUIT BREAKER LEAKAGE TYPE	30-300-500	1	8	2,2125	0,005351125
MTL42-4200	4P	42KA 200A TERMİK MANYETİK ŞALTER MOLDED CASE CIRCUIT BREAKER LEAKAGE TYPE	30-300-500	1	8	2,2125	0,005351125
MTL42-4250	4P	42KA 250A TERMİK MANYETİK ŞALTER MOLDED CASE CIRCUIT BREAKER LEAKAGE TYPE	30-300-500	1	8	2,2125	0,005351125
MTL50-40315	4P	50KA 315A TERMİK MANYETİK ŞALTER MOLDED CASE CIRCUIT BREAKER LEAKAGE TYPE	100-300-500	1	8	2,213	0,005351125
MTL50-40400	4P	50KA 400A TERMİK MANYETİK ŞALTER MOLDED CASE CIRCUIT BREAKER LEAKAGE TYPE	100-300-500	1	8	2,213	0,005351125
MTL50-40630	4P	50KA 630A TERMİK MANYETİK ŞALTER MOLDED CASE CIRCUIT BREAKER LEAKAGE TYPE	100-300-500	1	8	2,213	0,005351125
MTL50-40800	4P	50KA 800A TERMİK MANYETİK ŞALTER MOLDED CASE CIRCUIT BREAKER LEAKAGE TYPE	100-300-500	1	8	2,213	0,005351125

TERMİK MANYETİK AKSESUARLARI MCCB ACCESSORIES

KOD CODE	AÇIKLAMA DESCRIPTION	KUTU BOX	KOLİ PARCEL	KUTU AĞIRLIK BOX WEIGHT kg	KUTU HACİM BOX VOLUME m3
MTAUX-11250	1NO + 1NC YARDIMCI KONTAK - 160 VE 250A 1NO + 1NC AUXILIARY CONTACT - 160 AND 250A	30	720	0,75	0,001294125
MTAUX-22250	2NO + 2NC YARDIMCI KONTAK - 160 VE 250A 2NO + 2NC AUXILIARY CONTACT - 160 AND 250A	30	540	0,9999	0,00329301
MTALR-00160	ALARM KONTAKT 160A ALARM CONTACT 160A	30	720	0,75	0,001294125
MTALR-00250	ALARM KONTAKT 250A ALARM CONTACT 250A	30	540	0,9999	0,00329301
MTSHT-230160	230V ŞANT TRIP BOBİNİ 160A 230V SHUNT TRIP COIL 160A	30	720	0,75	0,001294125
MTSHT-230250	230V ŞANT TRIP BOBİNİ 250A 230V SHUNT TRIP COIL 250A	30	540	0,9999	0,00329301

AÇIK TİP DEVRE KESİCİLER

AIR CIRCUIT BREAKERS

SABİT TİP
FIXED TYPE

MTACF SERİSİ

TEKNİK BİLGİLER
TECHNICAL INFORMATION



KOD CODE	KUTUP SAYISI POLES	AÇIKLAMA DESCRIPTION	KUTU BOX	KOLİ PARCEL	KUTU AĞIRLIK BOX WEIGHT kg	KUTU HACİM BOX VOLUME m ³
MTACF3-0651000	3P	65KA 1000A AÇIK TİP DEVRE KESİCİ AIR CIRCUIT BREAKERS	1	1	54	0,115197
MTACF3-0651250	3P	65KA 1250A AÇIK TİP DEVRE KESİCİ AIR CIRCUIT BREAKERS	1	1	54	0,115197
MTACF3-0651600	3P	65KA 1600A AÇIK TİP DEVRE KESİCİ AIR CIRCUIT BREAKERS	1	1	56,1	0,115197
MTACF3-0652000	3P	65KA 2000A AÇIK TİP DEVRE KESİCİ AIR CIRCUIT BREAKERS	1	1	56,1	0,115197
MTACF3-0652500	3P	65KA 2500A AÇIK TİP DEVRE KESİCİ AIR CIRCUIT BREAKERS	1	1	66	0,124488
MTACF3-0653200	3P	65KA 3200A AÇIK TİP DEVRE KESİCİ AIR CIRCUIT BREAKERSİ	1	1	66	0,124488
MTACF3-1204000	3P	120KA 4000A AÇIK TİP DEVRE KESİCİ AIR CIRCUIT BREAKERS	1	1	110	0,420608
MTACF3-1205000	3P	120KA 5000A AÇIK TİP DEVRE KESİCİ AIR CIRCUIT BREAKERS	1	1	120	0,420608
MTACF3-1206300	3P	120KA 6300A AÇIK TİP DEVRE KESİCİ AIR CIRCUIT BREAKERS	1	1	130	0,420608
MTACF4-0651000	4P	65KA 1000A AÇIK TİP DEVRE KESİCİ AIR CIRCUIT BREAKERS	1	1	69,3	0,124488
MTACF4-0651250	4P	65KA 1250A AÇIK TİP DEVRE KESİCİ AIR CIRCUIT BREAKERS	1	1	69,3	0,124488
MTACF4-0651600	4P	65KA 1600A AÇIK TİP DEVRE KESİCİ AIR CIRCUIT BREAKERS	1	1	69,3	0,124488
MTACF4-0652000	4P	65KA 2000A AÇIK TİP DEVRE KESİCİ AIR CIRCUIT BREAKERS	1	1	71,3	0,124488
MTACF4-0652500	4P	65KA 2500A AÇIK TİP DEVRE KESİCİ AIR CIRCUIT BREAKERS	1	1	90	0,23316
MTACF4-0653200	4P	65KA 3200A AÇIK TİP DEVRE KESİCİ AIR CIRCUIT BREAKERS	1	1	92,5	0,23316
MTACF4-1204000	4P	120KA 4000A AÇIK TİP DEVRE KESİCİ AIR CIRCUIT BREAKERS	1	1	140,3	0,420608
MTACF4-1205000	4P	120KA 5000A AÇIK TİP DEVRE KESİCİ AIR CIRCUIT BREAKERS	1	1	151,2	0,420608
MTACF4-1206300	4P	120KA 6300A AÇIK TİP DEVRE KESİCİ AIR CIRCUIT BREAKERS	1	1	162,3	0,420608

ÇEKMECELİ TİP
DRAWER TYPE

MTACD SERİSİ

TEKNİK BİLGİLER
TECHNICAL INFORMATION



KOD CODE	KUTUP SAYISI POLES	AÇIKLAMA DESCRIPTION	KUTU BOX	KOLİ PARCEL	KUTU AĞIRLIK BOX WEIGHT kg	KUTU HACİM BOX VOLUME m ³
MTACD3-0651000	3P	65KA 1000A AÇIK TİP DEVRE KESİCİ AIR CIRCUIT BREAKERS	1	1	79,5	0,14664
MTACD3-0651250	3P	65KA 1250A AÇIK TİP DEVRE KESİCİ AIR CIRCUIT BREAKERS	1	1	79,5	0,14664
MTACD3-0651600	3P	65KA 1600A AÇIK TİP DEVRE KESİCİ AIR CIRCUIT BREAKERS	1	1	79,5	0,14664
MTACD3-0652000	3P	65KA 2000A AÇIK TİP DEVRE KESİCİ AIR CIRCUIT BREAKERS	1	1	85,5	0,14664
MTACD3-0652500	3P	65KA 2500A AÇIK TİP DEVRE KESİCİ AIR CIRCUIT BREAKERS	1	1	110	0,20088
MTACD3-0653200	3P	65KA 3200A AÇIK TİP DEVRE KESİCİ AIR CIRCUIT BREAKERS	1	1	110,5	0,20088
MTACD3-1204000	3P	120KA 4000A AÇIK TİP DEVRE KESİCİ AIR CIRCUIT BREAKERS	1	1	175	0,420608
MTACD3-1205000	3P	120KA 5000A AÇIK TİP DEVRE KESİCİ AIR CIRCUIT BREAKERS	1	1	200	0,420608
MTACD3-1206300	3P	120KA 6300A AÇIK TİP DEVRE KESİCİ AIR CIRCUIT BREAKERS	1	1	220	0,420608
MTACD4-0651000	4P	65KA 1000A AÇIK TİP DEVRE KESİCİ AIR CIRCUIT BREAKERS	1	1	98,8	0,20088
MTACD4-0651250	4P	65KA 1250A AÇIK TİP DEVRE KESİCİ AIR CIRCUIT BREAKERS	1	1	98,8	0,20088
MTACD4-0651600	4P	65KA 1600A AÇIK TİP DEVRE KESİCİ AIR CIRCUIT BREAKERS	1	1	98,8	0,20088
MTACD4-0652000	4P	65KA 2000A AÇIK TİP DEVRE KESİCİ AIR CIRCUIT BREAKERS	1	1	105,9	0,20088
MTACD4-0652500	4P	65KA 2500A AÇIK TİP DEVRE KESİCİ AIR CIRCUIT BREAKERS	1	1	123	0,23316
MTACD4-0653200	4P	65KA 3200A AÇIK TİP DEVRE KESİCİ AIR CIRCUIT BREAKERS	1	1	133	0,23316
MTACD4-1204000	4P	120KA 4000A AÇIK TİP DEVRE KESİCİ AIR CIRCUIT BREAKERS	1	1	195	0,420608
MTACD4-1205000	4P	120KA 5000A AÇIK TİP DEVRE KESİCİ AIR CIRCUIT BREAKERS	1	1	215	0,420608
MTACD4-1206300	4P	120KA 6300A AÇIK TİP DEVRE KESİCİ AIR CIRCUIT BREAKERS	1	1	225	0,420608

TOROID TRAFÖ

TOROIDAL TRANSFORMER



Düşük Elektromanyetik Girişim (EMI): Minimum EMI yayılımı ile hassas elektronik cihazların yanında güvenle kullanım sağlar.

Low Electromagnetic Interference (EMI): Enables safe use next to sensitive electronic devices with minimum EMI emissions.

MTC00 SERİSİ

TEKNİK BİLGİLER TECHNICAL INFORMATION

KOD CODE	AÇIKLAMA DESCRIPTION	KUTU BOX	KOLİ ADET PARCEL	AĞIRLIK WEIGHT	HACİM VOLUME
MTC00-040	40MM TOROID AKIM TRAFÖSÜ TOROID CURRENT TRANSFORMER	1	100	0,14	0,000418
MTC00-080	80MM TOROID AKIM TRAFÖSÜ TOROID CURRENT TRANSFORMER	1	60	0,265	0,000934999
MTC00-120	120MM TOROID AKIM TRAFÖSÜ TOROID CURRENT TRANSFORMER	1	60	0,34167	0,001528967
MTC00-160	160MM TOROID AKIM TRAFÖSÜ TOROID CURRENT TRANSFORMER	1	30	0,55667	0,002645833
MTC00-210	210MM TOROID AKIM TRAFÖSÜ TOROID CURRENT TRANSFORMER	1	28	0,83929	0,003622929

KAÇAK AKIM ALGILAMA RÖLESİ

EARTH LEAKAGE RELAY



Toroid transformatöründen gelen kaçak akımı ölçerek belirlenen kaçak akım seviyesinin aşılması durumunda devre kesicinin devreyi kesmesini sağlar.

It measures the leakage current coming from the toroid transformer and ensures that the circuit breaker cuts the circuit if the determined leakage current level is exceeded.

MTC00 SERİSİ

TEKNİK BİLGİLER TECHNICAL INFORMATION

KOD CODE	AÇIKLAMA DESCRIPTION	KUTU BOX	KOLİ ADET PARCEL	AĞIRLIK WEIGHT	HACİM VOLUME
MELR00-01	KAÇAK ALGILAMA RÖLESİ EARTH LEAKAGE RELAY	1	36	0,331	0,000714792

ANALOG ZAMAN SAATİ

ANALOG TIMER

Belirlenen zaman dilimlerine dayalı olarak elektrik devrelerini açıp kapatan bir kontrol cihazıdır. Mekanik veya elektronik bileşenler kullanarak zamanlama işlevlerini gerçekleştirir.

It is a control device that turns electrical circuits on and off based on specified time periods. It performs timing functions using mechanical or electronic components.



ANALOG ZAMAN SAATİ

ANALOG TIMER

Endüstriyel kontrol sistemlerinde, aydınlatma yönetimi, motor kontrolü ve süreç otomasyonunda kullanılır.

It is used in industrial control systems, lighting management, motor control and process automation.



Zaman saatlerinin kullanım yerleri oldukça geniştir. Belirli saatlerde çalışması yine belirlenen süre sonunda devreden çıkması istenen tüm uygulamalarda, örneğin Park sulama sistemleri, yol aydınlatma sistemleri, tarımsal sulama sistemleri, okul-işyeri zili, ısıtma-soğutma sistemlerinde kullanılır. Böylece bu sistemlerin kullanıcı müdahalesi olmadan otomatik olarak ve sadece istenilen süre kadar çalışması sağlanır.

Analog Timer Relay have a wide range of uses. It is used in all applications where it is required to operate at certain hours and be deactivated at the end of the specified period, for example, park irrigation systems, road lighting systems, agricultural irrigation systems, school-office bells, heating-cooling systems. This ensures that these systems operate automatically and only for the desired period of time, without user intervention.

MATRO SERİSİ

TEKNİK BİLGİLER

TECHNICAL INFORMATION

KOD CODE	AÇIKLAMA DESCRIPTION	KUTU BOX	KOLİ PARCEL	KUTU AĞIRLIK BOX WEIGHT kg	KUTU HACİM BOX VOLUME m3
MATRO-100	100SA ANALOG ZAMAN SAATİ ANALOG TIMER	1	100	0,088	0,0002162

DARBE AKIM RÖLESİ

IMPULSE RELAY

Endüstriyel ve ticari tesislerde, elektrik sistemlerini, kısa devre veya yıldırım darbeleri gibi ani yüksek akım artışlarından korumak için kullanılır.

It is used in industrial and commercial facilities to protect electrical systems from sudden high current increases such as short circuits or lightning strikes.



Gelişmiş sensörler ve hassas algılama teknolojisi ile ani yüksek akım darbelerine karşı hızlı ve etkili koruma sağlar. Yenilikçi tasarımı, enerji verimliliğini ve sistem güvenliğini artırırken, modüler yapı ve düşük güç tüketimi ile maliyet etkinliği sunar.

With advanced sensors and sensitive detection technology, it provides fast and effective protection against sudden high current pulses. Its innovative design increases energy efficiency and system security, while offering cost efficiency with modular structure and low power consumption.

- Elektrik sistemlerini ani akım artışlarından korur.
Protects electrical systems from sudden current increases
- Ekipman ve devrelerin hasardan korunmasını sağlar.
Equipment and circuits provides protection from damage.
- Darbe akımı anlık yüksek akımlara, kaçak akım sürekli kaçaqlara karşı korur.
Impulse current to instantaneous high currents, Leakage current constantly protects against leaks.

Anlık yüksek akım darbelerini algılayıp tepki veren bir elektrik koruma cihazıdır. Darbe akım röleleri, algıladıkları anormal akım seviyelerine hızlı bir şekilde tepki vererek, sistemi korumak üzere tasarlanmış devreleri aktif hale getirir veya devreyi keser. Bu sayede, elektrikli ekipmanlar ve devreler aşırı akım hasarından korunmuş olur.

It is an electrical protection device that detects and reacts to instantaneous high current pulses. Impulse current relays react quickly to abnormal current levels they detect, activating or breaking circuits designed to protect the system. In this way, electrical devices and circuits are free from overcurrent damage.

MIR00 SERİSİ

TEKNİK BİLGİLER

TECHNICAL INFORMATION

KOD CODE	AÇIKLAMA DESCRIPTION	KUTU BOX	KOLİ PARCEL	KUTU AĞIRLIK BOX WEIGHT kg	KUTU HACİM BOX VOLUME m3
MIR00-123016	16A 1NO DARBE AKIM ANAHTARI IMPULSE RELAY	1	120	0,122	0,000205833
MIR00-223016	16A 2NO DARBE AKIM ANAHTARI IMPULSE RELAY	1	120	0,122	0,000205833

Üstün malzeme kalitesi ve ileri mühendislik ile yüksek güvenilirlik ve uzun ömür sunar. Düşük enerji tüketimli bobinleri, enerji verimliliğini artırırken, geniş ürün yelpazesi farklı akım ve voltaj ihtiyaçlarına uygun çözümler sağlar.

It offers high distribution and long life with superior material quality and advanced engineering. While its low energy consumption coils increase the energy range, its wide product range provides solutions suitable for different currents and voltages.

Alternatif akım (AC) sistemlerinde kullanılan bir tür elektrikli anahtarlama cihazıdır. Genellikle, yüksek akım taşıyan elektrik devrelerini uzaktan kontrol etmek, bağlamak ve kesmek için tasarlanmıştır. 9A-95A aralığında 4kW-45kW olmak üzere Aksesuar seçenekleriyle sunulmaktadır.

It is a type of electrical switching device used in alternating current (AC) systems. They are generally designed to remotely control, connect and disconnect electrical circuits carrying high currents. It is offered with accessory options in the range of 9A-95A, 4kW-45kW.



■ Kontaktör serisi, 600V AC anma gerilimine, 50Hz veya 60Hz frekansına, 220V'a kadar DC gerilimine, 95A anma akımına kadar açma ve kapama için devrede kullanıma uygundur

■ Asansörler, elektrik motorları, aydınlatma sistemleri, ısıtma, havalandırma ve klima (HVAC) sistemleri gibi uygulamalarda yaygın olarak kullanılırlar.

■ Contactor series contactor is suitable for using in the circuit up to therated voltage 600V AC 50Hz or 60Hz,DC voltage 220V ratecurrent Suitable for use in circuits for opening and closing up to 95A rated current

■ They are widely used in applications such as elevators, electric motors, lighting systems, and heating, ventilation, and air conditioning (HVAC) systems.

AC KONTAKTÖR AC CONTACTOR



MTMA SERİSİ

TEKNİK BİLGİLER
TECHNICAL INFORMATION

KOD CODE	KUTUP SAYISI POLES	AÇIKLAMA DESCRIPTION	KUTU BOX	KOLİ PARCEL	KUTU AĞIRLIK BOX WEIGHT kg	KUTU HACİM BOX VOLUME m ³
MTMA10-3009	3P	9A 4KW/AC-3 KONTAKTÖR CONTACTOR (1NO) 230 V AC	1	60	0,227	0,00429
MTMA01-3009	3P	9A 4KW/AC-3 KONTAKTÖR CONTACTOR (1NC) 230 V AC	1	60	0,227	0,00429
MTMA10-3012	3P	12A 5.5KW/AC-3 KONTAKTÖR CONTACTOR (1NO) 230 V AC	1	60	0,227	0,00429
MTMA01-3012	3P	12A 5.5KW/AC-3 KONTAKTÖR CONTACTOR (1NC) 230 V AC	1	60	0,227	0,00429
MTMA10-3018	3P	18A 7.5KW/AC-3 KONTAKTÖR CONTACTOR (1NO) 230 V AC	1	60	0,227	0,00429
MTMA01-3018	3P	18A 7.5KW/AC-3 KONTAKTÖR CONTACTOR (1NC) 230 V AC	1	60	0,227	0,00429
MTMA10-3025	3P	25A 11KW/AC-3 KONTAKTÖR CONTACTOR (1NO) 230 V AC	1	40	0,227	0,000687
MTMA01-3025	3P	25A 11KW/AC-3 KONTAKTÖR CONTACTOR (1NC) 230 V AC	1	40	0,227	0,000687
MTMA10-3032	3P	32A 15KW/AC-3 KONTAKTÖR CONTACTOR (1NO) 230 V AC	1	40	0,227	0,000687
MTMA01-3032	3P	32A 15KW/AC-3 KONTAKTÖR CONTACTOR (1NC) 230 V AC	1	40	0,227	0,000687
MTMA10-3040	3P	40A 18.5KW/AC-3 KONTAKTÖR CONTACTOR (1NO) 230 V AC	1	40	0,227	0,000687
MTMA01-3040	3P	40A 18.5KW/AC-3 KONTAKTÖR CONTACTOR (1NC) 230 V AC	1	40	0,227	0,000687
MTMA11-3050	3P	50A 22KW/AC-3 KONTAKTÖR CONTACTOR (1NO+1NC) 230 V AC	1	16	1,031	0,001680075
MTMA11-3065	3P	65A 30KW/AC-3 KONTAKTÖR CONTACTOR (1NO+1NC) 230 V AC	1	16	1,031	0,001680075
MTMA11-3080	3P	80A 37KW/AC-3 KONTAKTÖR CONTACTOR (1NO+1NC) 230 V AC	1	12	1,417	0,001989167
MTMA11-3095	3P	95A 45KW/AC-3 KONTAKTÖR CONTACTOR (1NO+1NC) 230 V AC	1	12	1,417	0,001989167



AC KONTAKTÖR YARDIMCI BLOKLAR AC CONTACTOR AUXILIARY BLOCKS

KOD CODE	AÇIKLAMA DESCRIPTION	KUTU BOX	KOLİ PARCEL	KUTU AĞIRLIK BOX WEIGHT kg	KUTU HACİM BOX VOLUME m ³
MTMAUX-UPBLOCKA	AC-3 KONTAKTÖR ÜST BLOK A (1NO + 1NC) AC CONTACTOR AUXILIARY BLOCKS	1	1	0,195	0,000343403
MTMAUX-UPBLOCKB	AC-3 KONTAKTÖR ÜST BLOK B (2NO + 2NC) AC CONTACTOR AUXILIARY BLOCKS	1	1	0,195	0,000343403
MTMAUX-SIDEBLOCK	AC-3 KONTAKTÖR YAN BLOK (1NO + 1NC) AC CONTACTOR AUXILIARY BLOCKS	1	1	0,195	0,000343403

MİNİ KONTAKTÖRLER

MINI CONTACTORS

MTMK SERİSİ

TEKNİK BİLGİLER
TECHNICAL INFORMATION



KOD CODE	KUTUP SAYISI POLES	AÇIKLAMA DESCRIPTION	KUTU BOX	KOLİ PARCEL	KUTU AĞIRLIK BOX WEIGHT kg	KUTU HACİM BOX VOLUME m ³
MTMK10-3009	3P	3P 9A 4KW MİNİ KONTAKTÖR MINI CONTACTORS (1NO) 230 V AC	1	100	0,194	0,00023205
MTMK10-3012	3P	3P 12A 5,5KW MİNİ KONTAKTÖR MINI CONTACTORS (1NO) 230 V AC	1	100	0,194	0,00023205
MTMK10-3016	3P	3P 16A 7,5KW MİNİ KONTAKTÖR MINI CONTACTORS (1NO) 230 V AC	1	100	0,194	0,00023205
MTMK01-3009	3P	3P 9A 4KW MİNİ KONTAKTÖR MINI CONTACTORS (1NC) 230C AC	1	100	0,194	0,00023205
MTMK01-3012	3P	3P 12A 5.5KW MİNİ KONTAKTÖR MINI CONTACTORS (1NC) 230C AC	1	100	0,194	0,00023205
MTMK01-3016	3P	3P 16A 7.5KW MİNİ KONTAKTÖR MINI CONTACTORS (1NC) 230C AC	1	100	0,194	0,00023205
MTMK10-3009DC24	3P	3P 9A 4KW MİNİ KONTAKTÖR MINI CONTACTORS (1NO) 24V DC	1	100	0,194	0,00023205
MTMK10-3012DC24	3P	3P 12A 5.5KW MİNİ KONTAKTÖR MINI CONTACTORS (1NO) 24V DC	1	100	0,194	0,00023205
MTMK10-3016DC24	3P	3P 16A 7.5KW MİNİ KONTAKTÖR MINI CONTACTORS (1NO) 24V DC	1	100	0,194	0,00023205
MTMK01-3009DC24	3P	3P 9A 4KW MİNİ KONTAKTÖR MINI CONTACTORS (1NC) 24V DC	1	100	0,194	0,00023205
MTMK01-3012DC24	3P	3P 12A 5.5KW MİNİ KONTAKTÖR MINI CONTACTORS (1NC) 24V DC	1	100	0,194	0,00023205
MTMK01-3016DC24	3P	3P 16A 7.5KW MİNİ KONTAKTÖR MINI CONTACTORS (1NC) 24V DC	1	100	0,194	0,00023205

AC KOMPANZASYON KONTAKTÖRLERİ

AC COMPENSATION CONTACTORS

MTMAC SERİSİ

TEKNİK BİLGİLER
TECHNICAL INFORMATION

KOD CODE	KUTUP SAYISI POLES	AÇIKLAMA DESCRIPTION	KUTU BOX	KOLİ PARCEL	BİRİM AĞIRLIK UNIT WEIGHT kg	BİRİM HACİM UNIT VOLUME m ³
MTMAC1-318	3P	18A 7,5KVAR	1	32	0,594	0,001300777
MTMAC1-325	3P	25A 12KVAR	1	32	0,625	0,001300777
MTMAC1-332	3P	32A 18KVAR	1	32	0,625	0,001300777
MTMAC1-343	3P	43A 20KVAR	1	16	0,625	0,001300777
MTMAC1-350	3P	50A 25KVAR	1	16	1,063	0,00266475
MTMAC1-365	3P	65A 30KVAR	1	16	0,625	0,001300777
MTMAC1-380	3P	80A 40KVAR	1	16	1,063	0,00266475
MTMAC1-395	3P	95A 50KVAR	1	16	1,063	0,00266475



MODÜLER KONTAKTÖRLER

MODULAR CONTACTOR

MTMCO SERİSİ

TEKNİK BİLGİLER

TECHNICAL INFORMATION



KOD CODE	KUTUP SAYISI POLES	AÇIKLAMA DESCRIPTION	KUTU BOX	KOLİ PARCEL	KUTU AĞIRLIK BOX WEIGHT kg	KUTU HACİM BOX VOLUME m3
MTMCO-201611	2P	16A 1NO+1NC 18MM MODÜLER KONTAKTÖR MODULAR CONTACTOR	1	140	0,12929	0,000190286
MTMCO-201620	2P	16A 2NO 18MM MODÜLER KONTAKTÖR MODULAR CONTACTOR	1	140	0,12929	0,000190286
MTMCO-201602	2P	16A 2NC 18MM MODÜLER KONTAKTÖR MODULAR CONTACTOR	1	140	0,12929	0,000190286
MTMCO-202511	2P	25A 1NO+1NC 18MM MODÜLER KONTAKTÖR MODULAR CONTACTOR	1	140	0,12929	0,000190286
MTMCO-202520	2P	25A 2NO 18MM MODÜLER KONTAKTÖR MODULAR CONTACTOR	1	140	0,12929	0,000190286
MTMCO-202502	2P	25A 2NC 18MM MODÜLER KONTAKTÖR MODULAR CONTACTOR	1	140	0,12929	0,000190286
MTMCO-203211	2P	32A 1NO+1NC 36MM MODÜLER KONTAKTÖR MODULAR CONTACTOR	1	70	0,25286	0,000380571
MTMCO-203220	2P	32A 2NO 36MM MODÜLER KONTAKTÖR MODULAR CONTACTOR	1	70	0,25286	0,000380571
MTMCO-203202	2P	32A 2NC 36MM MODÜLER KONTAKTÖR MODULAR CONTACTOR	1	70	0,25286	0,000380571
MTMCO-204011	2P	40A 1NO+1NC 36MM MODÜLER KONTAKTÖR MODULAR CONTACTOR	1	70	0,25286	0,000380571
MTMCO-204020	2P	40A 2NO 36MM MODÜLER KONTAKTÖR MODULAR CONTACTOR	1	70	0,25286	0,000380571
MTMCO-204002	2P	40A 2NC 36MM MODÜLER KONTAKTÖR MODULAR CONTACTOR	1	70	0,25286	0,000380571
MTMCO-206311	2P	63A 1NO+1NC 36MM MODÜLER KONTAKTÖR MODULAR CONTACTOR	1	70	0,25286	0,000380571
MTMCO-206320	2P	63A 2NO 36MM MODÜLER KONTAKTÖR MODULAR CONTACTOR	1	70	0,25286	0,000380571
MTMCO-206302	2P	63A 2NC 36MM MODÜLER KONTAKTÖR MODULAR CONTACTOR	1	70	0,25286	0,000380571
MTMCO-208011	2P	80A 1NO+1NC 54MM MODÜLER KONTAKTÖR MODULAR CONTACTOR	1	50	0,404	0,0005328
MTMCO-208020	2P	80A 2NO 54MM MODÜLER KONTAKTÖR MODULAR CONTACTOR	1	50	0,404	0,0005328
MTMCO-208002	2P	80A 2NC 54MM MODÜLER KONTAKTÖR MODULAR CONTACTOR	1	50	0,404	0,0005328
MTMCO-2010011	2P	100A 1NO+1NC 54MM MODÜLER KONTAKTÖR MODULAR CONTACTOR	1	50	0,404	0,0005328
MTMCO-2010020	2P	100A 2NO 54MM MODÜLER KONTAKTÖR MODULAR CONTACTOR	1	50	0,404	0,0005328
MTMCO-2010002	2P	100A 2NC 54MM MODÜLER KONTAKTÖR MODULAR CONTACTOR	1	50	0,404	0,0005328
MTMCO-401622	4P	16A 2NO+2NC 36MM MODÜLER KONTAKTÖR MODULAR CONTACTOR	1	70	0,23286	0,000380571
MTMCO-401631	4P	16A 3NO+1NC 36MM MODÜLER KONTAKTÖR MODULAR CONTACTOR	1	70	0,23286	0,000380571
MTMCO-401613	4P	16A 1NO+3NC 36MM MODÜLER KONTAKTÖR MODULAR CONTACTOR	1	70	0,23286	0,000380571
MTMCO-401640	4P	16A 4NO 36MM MODÜLER KONTAKTÖR MODULAR CONTACTOR	1	70	0,23286	0,000380571
MTMCO-401604	4P	16A 4NC 36MM MODÜLER KONTAKTÖR MODULAR CONTACTOR	1	70	0,23286	0,000380571
MTMCO-402522	4P	25A 2NO+2NC 36MM MODÜLER KONTAKTÖR MODULAR CONTACTOR	1	70	0,23286	0,000380571
MTMCO-402531	4P	25A 3NO+1NC 36MM MODÜLER KONTAKTÖR MODULAR CONTACTOR	1	70	0,23286	0,000380571
MTMCO-402513	4P	25A 1NO+3NC 36MM MODÜLER KONTAKTÖR MODULAR CONTACTOR	1	70	0,23286	0,000380571
MTMCO-402540	4P	25A 4NO 36MM MODÜLER KONTAKTÖR MODULAR CONTACTOR	1	70	0,23286	0,000380571
MTMCO-402504	4P	25A 4NC 36MM MODÜLER KONTAKTÖR MODULAR CONTACTOR	1	70	0,23286	0,000380571
MTMCO-403222	4P	32A 2NO+2NC 54MM MODÜLER KONTAKTÖR MODULAR CONTACTOR	1	50	0,366	0,0005328
MTMCO-403231	4P	32A 3NO+1NC 54MM MODÜLER KONTAKTÖR MODULAR CONTACTOR	1	50	0,366	0,0005328
MTMCO-403213	4P	32A 1NO+3NC 54MM MODÜLER KONTAKTÖR MODULAR CONTACTOR	1	50	0,366	0,0005328
MTMCO-403240	4P	32A 4NO 54MM MODÜLER KONTAKTÖR MODULAR CONTACTOR	1	50	0,366	0,0005328
MTMCO-403204	4P	32A 4NC 54MM MODÜLER KONTAKTÖR MODULAR CONTACTOR	1	50	0,366	0,0005328
MTMCO-404022	4P	40A 2NO+2NC 54MM MODÜLER KONTAKTÖR MODULAR CONTACTOR	1	50	0,366	0,0005328
MTMCO-404031	4P	40A 3NO+1NC 54MM MODÜLER KONTAKTÖR MODULAR CONTACTOR	1	50	0,366	0,0005328
MTMCO-404013	4P	40A 1NO+3NC 54MM MODÜLER KONTAKTÖR MODULAR CONTACTOR	1	50	0,366	0,0005328
MTMCO-404040	4P	40A 4NO 54MM MODÜLER KONTAKTÖR MODULAR CONTACTOR	1	50	0,366	0,0005328
MTMCO-404004	4P	40A 4NC 54MM MODÜLER KONTAKTÖR MODULAR CONTACTOR	1	50	0,366	0,0005328
MTMCO-406322	4P	63A 2NO+2NC 54MM MODÜLER KONTAKTÖR MODULAR CONTACTOR	1	50	0,366	0,0005328
MTMCO-406331	4P	63A 3NO+1NC 54MM MODÜLER KONTAKTÖR MODULAR CONTACTOR	1	50	0,366	0,0005328
MTMCO-406313	4P	63A 1NO+3NC 54MM MODÜLER KONTAKTÖR MODULAR CONTACTOR	1	50	0,366	0,0005328
MTMCO-406340	4P	63A 4NO 54MM MODÜLER KONTAKTÖR MODULAR CONTACTOR	1	50	0,366	0,0005328
MTMCO-406304	4P	63A 4NC 54MM MODÜLER KONTAKTÖR MODULAR CONTACTOR	1	50	0,366	0,0005328
MTMCO-408022	4P	80A 2NO+2NC 108MM MODÜLER KONTAKTÖR MODULAR CONTACTOR	1	30	0,673	0,0008372
MTMCO-408031	4P	80A 3NO+1NC 108MM MODÜLER KONTAKTÖR MODULAR CONTACTOR	1	30	0,673	0,0008372
MTMCO-408013	4P	80A 1NO+3NC 108MM MODÜLER KONTAKTÖR MODULAR CONTACTOR	1	30	0,673	0,0008372
MTMCO-408080	4P	80A 4NO 108MM MODÜLER KONTAKTÖR MODULAR CONTACTOR	1	30	0,673	0,0008372
MTMCO-408004	4P	80A 4NC 108MM MODÜLER KONTAKTÖR MODULAR CONTACTOR	1	30	0,673	0,0008372
MTMCO-410022	4P	100A 2NO+2NC 108MM MODÜLER KONTAKTÖR MODULAR CONTACTOR	1	30	0,673	0,0008372
MTMCO-410031	4P	100A 3NO+1NC 108MM MODÜLER KONTAKTÖR MODULAR CONTACTOR	1	30	0,673	0,0008372
MTMCO-410013	4P	100A 1NO+3NC 108MM MODÜLER KONTAKTÖR MODULAR CONTACTOR	1	30	0,673	0,0008372
MTMCO-410040	4P	100A 4NO 108MM MODÜLER KONTAKTÖR MODULAR CONTACTOR	1	30	0,673	0,0008372
MTMCO-410004	4P	100A 4NC 108MM MODÜLER KONTAKTÖR MODULAR CONTACTOR	1	30	0,673	0,0008372



MTTR SERİSİ

TEKNİK BİLGİLER
TECHNICAL INFORMATION

KOD CODE	KUTUP SAYISI POLES	AÇIKLAMA DESCRIPTION	KUTU BOX	KOLİ PARCEL	KUTU AĞIRLIK BOX WEIGHT kg	KUTU HACİM BOX VOLUME m ³
MTTR1-M1301	3P	0.1-0.16A TERMİK RÖLE THERMAL RELAYS	1	100	0,176	0,000421785
MTTR1-M1302	3P	0.16-0.25A TERMİK RÖLE THERMAL RELAYS	1	100	0,176	0,000421785
MTTR1-M1303	3P	0.25-0.4A TERMİK RÖLE THERMAL RELAYS	1	100	0,176	0,000421785
MTTR1-M1304	3P	0.4-0.63A TERMİK RÖLE THERMAL RELAYS	1	100	0,176	0,000421785
MTTR1-M1305	3P	0.63-1A TERMİK RÖLE THERMAL RELAYS	1	100	0,176	0,000421785
MTTR1-M1306	3P	1-1.6A TERMİK RÖLE THERMAL RELAYS	1	100	0,176	0,000421785
MTTR1-M1307	3P	1.6-2.5A TERMİK RÖLE THERMAL RELAYS	1	100	0,176	0,000421785
MTTR1-M1308	3P	2.5-4A TERMİK RÖLE THERMAL RELAYS	1	100	0,176	0,000421785
MTTR1-M1310	3P	4-6A TERMİK RÖLE THERMAL RELAYS	1	100	0,176	0,000421785
MTTR1-M1312	3P	5.5-8A TERMİK RÖLE THERMAL RELAYS	1	100	0,176	0,000421785
MTTR1-M1314	3P	7-10A TERMİK RÖLE THERMAL RELAYS	1	100	0,176	0,000421785
MTTR1-M1316	3P	9-13A TERMİK RÖLE THERMAL RELAYS	1	100	0,176	0,000421785
MTTR1-M1321	3P	12-18A TERMİK RÖLE THERMAL RELAYS	1	100	0,176	0,000421785
MTTR1-M1322	3P	17-25A TERMİK RÖLE THERMAL RELAYS	1	100	0,176	0,000421785
MTTR2-M2353	3P	23-32A TERMİK RÖLE THERMAL RELAYS	1	75	0,267	0,000565963
MTTR2-M2355	3P	30-40A TERMİK RÖLE THERMAL RELAYS	1	75	0,267	0,000565963
MTTR3-M3322	3P	17-25A TERMİK RÖLE (BÜYÜK) THERMAL RELAYS (BIG)	1	50	0,46	0,000848945
MTTR3-M3353	3P	23-32A TERMİK RÖLE (BÜYÜK) THERMAL RELAYS (BIG)	1	50	0,46	0,000848945
MTTR3-M3355	3P	30-40A TERMİK RÖLE (BÜYÜK) THERMAL RELAYS (BIG)	1	50	0,46	0,000848945
MTTR3-M3357	3P	37-50A TERMİK RÖLE THERMAL RELAYS	1	50	0,46	0,000848945
MTTR3-M3359	3P	48-65A TERMİK RÖLE THERMAL RELAYS	1	50	0,46	0,000848945
MTTR3-M3361	3P	55-70A TERMİK RÖLE THERMAL RELAYS	1	50	0,46	0,000848945
MTTR3-M3363	3P	63-80A TERMİK RÖLE THERMAL RELAYS	1	50	0,46	0,000848945
MTTR3-M3365	3P	80-93A TERMİK RÖLE THERMAL RELAYS	1	50	0,46	0,000848945

MOTOR KORUMA ŞALTERLERİ

MOTOR PROTECTION SWITCHES

MTPSO SERİSİ

TEKNİK BİLGİLER
TECHNICAL INFORMATION



KOD CODE	KUTUP SAYISI POLES	AÇIKLAMA DESCRIPTION	KUTU BOX	KOLİ PARCEL	KUTU AĞIRLIK BOX WEIGHT kg	KUTU HACİM BOX VOLUME m ³
MTPSO-250016	3P	0,1-0,16A MOTOR KORUMA ŞALTERİ MOTOR PROTECTION SWITCHES	1	50	0,304	0,0004884
MTPSO-250025	3P	0,16-0,25A MOTOR KORUMA ŞALTERİ MOTOR PROTECTION SWITCHES	1	50	0,304	0,0004884
MTPSO-250040	3P	0,25-0,4A MOTOR KORUMA ŞALTERİ MOTOR PROTECTION SWITCHES	1	50	0,304	0,0004884
MTPSO-250063	3P	0,40-0,63A MOTOR KORUMA ŞALTERİ MOTOR PROTECTION SWITCHES	1	50	0,304	0,0004884
MTPSO-250100	3P	0,63-1A MOTOR KORUMA ŞALTERİ MOTOR PROTECTION SWITCHES	1	50	0,304	0,0004884
MTPSO-250160	3P	1-1,6A MOTOR KORUMA ŞALTERİ MOTOR PROTECTION SWITCHES	1	50	0,304	0,0004884
MTPSO-250250	3P	1,6-2,5A MOTOR KORUMA ŞALTERİ MOTOR PROTECTION SWITCHES	1	50	0,304	0,0004884
MTPSO-250400	3P	2,5-4A MOTOR KORUMA ŞALTERİ MOTOR PROTECTION SWITCHES	1	50	0,304	0,0004884
MTPSO-250630	3P	4-6,3A MOTOR KORUMA ŞALTERİ MOTOR PROTECTION SWITCHES	1	50	0,304	0,0004884
MTPSO-251000	3P	6-10A MOTOR KORUMA ŞALTERİ MOTOR PROTECTION SWITCHES	1	50	0,304	0,0004884
MTPSO-251400	3P	9-14A MOTOR KORUMA ŞALTERİ MOTOR PROTECTION SWITCHES	1	50	0,304	0,0004884
MTPSO-251800	3P	13-18A MOTOR KORUMA ŞALTERİ MOTOR PROTECTION SWITCHES	1	50	0,304	0,0004884
MTPSO-252300	3P	17-23A MOTOR KORUMA ŞALTERİ MOTOR PROTECTION SWITCHES	1	50	0,304	0,0004884
MTPSO-252500	3P	20-25A MOTOR KORUMA ŞALTERİ MOTOR PROTECTION SWITCHES	1	50	0,304	0,0004884
MTPSO-253200	3P	24-32A MOTOR KORUMA ŞALTERİ MOTOR PROTECTION SWITCHES	1	50	0,304	0,0004884
MTPS1-804000	3P	25-40A MOTOR KORUMA ŞALTERİ MOTOR PROTECTION SWITCHES	1	25	0,92	0,874
MTPS1-805000	3P	36-50A MOTOR KORUMA ŞALTERİ MOTOR PROTECTION SWITCHES	1	25	0,92	0,874
MTPS1-806300	3P	40-63A MOTOR KORUMA ŞALTERİ MOTOR PROTECTION SWITCHES	1	25	0,92	0,874
MTPS1-808000	3P	56-80A MOTOR KORUMA ŞALTERİ MOTOR PROTECTION SWITCHES	1	25	0,92	0,874

MOTOR KORUMA AKSESUARLARI

MOTOR PROTECTION ACCESSORIES



MTPSO-F11	1NO + 1NC YARDIMCI KONTAK - ÖNDEN MONTELİ AUXILIARY CONTACT - FRONT MOUNTED	10	500	0,204	0,00062985
MTPSO-F20	2NO YARDIMCI KONTAK - ÖNDEN MONTELİ AUXILIARY CONTACT - FRONT MOUNTED	10	500	0,204	0,00062985
MTPSO-L11	MTMP-25 1NO + 1NC YARDIMCI KONTAK - YANDAN MONTELİ AUXILIARY CONTACT - SIDE MOUNTED	10	500	0,412	0,00152775
MTPSO-L20	MTMP-25 2NO YARDIMCI KONTAK - YANDAN MONTELİ AUXILIARY CONTACT - SIDE MOUNTED	10	500	0,412	0,00152775
MTPS1-L11	MTMP-80 1NO + 1NC YARDIMCI KONTAK - YANDAN MONTELİ AUXILIARY CONTACT - SIDE MOUNTED	10	500	0,42	0,001648
MTPS1-L20	MTMP-80 2NO YARDIMCI KONTAK - YANDAN MONTELİ AUXILIARY CONTACT - SIDE MOUNTED	10	500	0,42	0,001648
MTPSO-AB	230V ŞANT AÇTIRMA BOBİNİ	1	100	0,11	0,00031635
MTPSO-DG	400V DÜŞÜK GERİLİM AÇTIRMA BOBİNİ	1	100	0,11	0,00031635
MTPSO-IP55K	IP 55 KUTU - MOTOR KORUMA ŞALTERİ	1	50	0,364	0,00152775

YENİ
NEW

RAY KLEMENSLER

RAIL TERMINAL BLOCKS

PUSH-IN SERİSİ
VIDALI TİP SERİSİ

PUSH-IN SERIES
SCREW TYPE SERIES

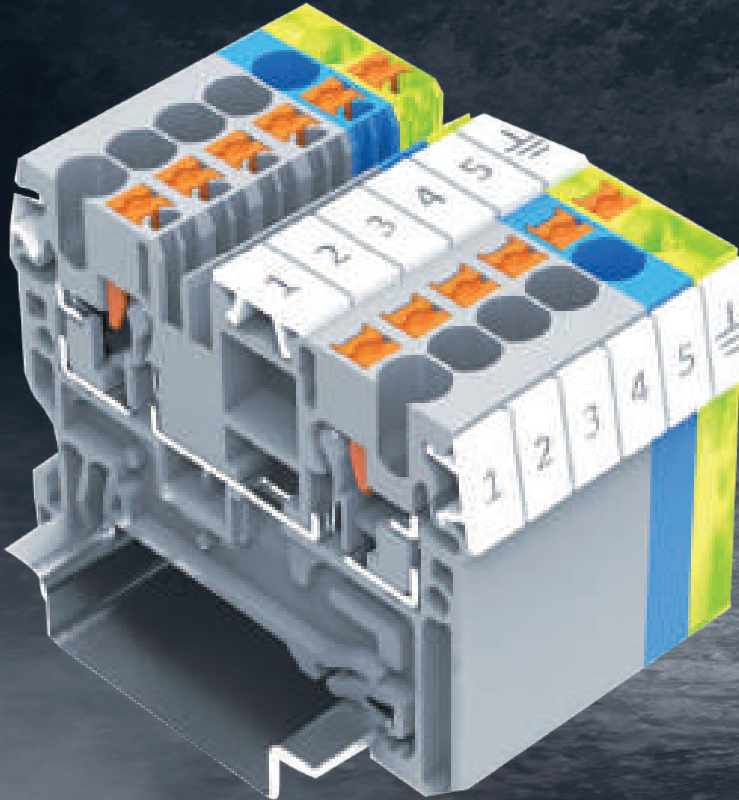

PUSH-IN TERMINAL BLOCKS

- ALETSİZ KABLOLAMA
- KOMPAKT BOYUT
- KABLOLAMA SÜRESİNDEN %75 TASARRUF
- İTMELİ ATLAMA TELLERİ
- YÜKSEK ÇEKME KUVVETİ
- TOOL FREE WIRING
- COMPACT SIZE
- SAVE %75 WIRING
- TIME PUSH-IN JUMPERS
- HIGH PULL-OUT FORCES

Güvenilirlik sorunlarını ortadan kaldırmak için çoklu bağlantı
Multiple connection to eliminate reliability problems

Takılabilir jumper'lar kullanılarak köprüleme için iki bağımsız sıra. Jumper'lar, kısa pozisyonları belirtmek için keçeli kalemle işaretlenebilir
Two independent rows for bridging using pluggable jumpers. Jumpers can be marked with a felt tip pen to indicate shorted positions

Daha iyi görünürlük ve tanımlama için yükseltilmiş grup işareti
Raised group marker for better visibility & identification

8 Seviyeli Mareşalleme Terminal Bloğu
8 Level Marshalling Terminal Block

1,5 mm² kablolar için 3,5 mm kalınlığında en ince terminal bloğu
Thinnest Terminal Block in 3.5 mm thickness for 1.5 mm² wires

-Sensör ve Aktüatör Terminal Bloğu
-Makine ve sistem kontrolörü için 3,5 mm ince kompakt Terminaller
-Sensor and Actuator Terminal Block
-3.5 mm thin compact Terminals for machine and system controller

Her seviyede bağımsız ayırma özelliğine sahip Çift Seviyeli Ayırma Terminal Bloğu
Double Level Disconnect Terminal Block with independent Disconnection at each level

Endüstri standartlarına göre sarı-yeşil renk kodlu topraklama kablolarını sonlandırmak için Topraklama Terminal Blokları
Earthing Terminal Blocks for terminating earthing wires coded yellow-green colour as per industry standards

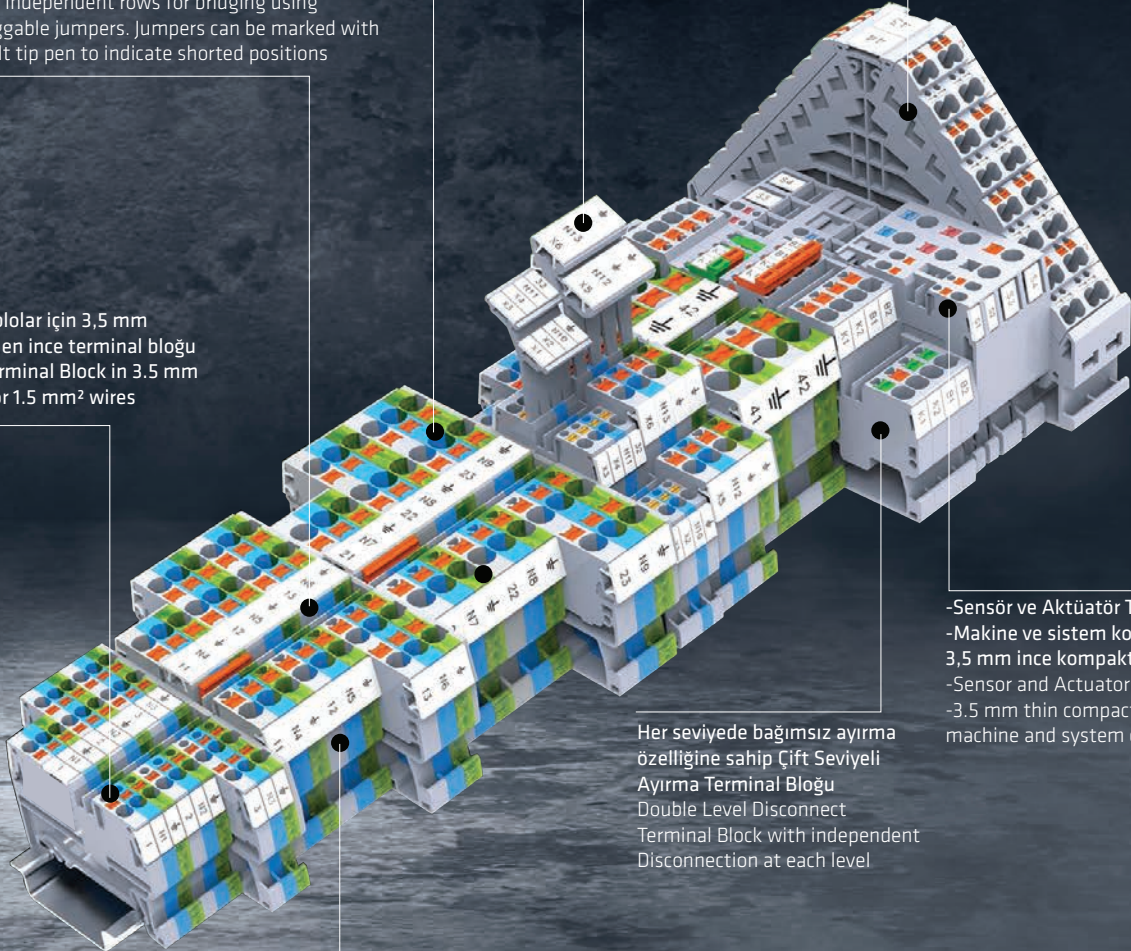

RAY KLEMENSLER VİDALI TİP • RAIL TERMINALS SCREWED TYPE

XX : 00 GRİ
 XX : 14 SARIL
 XX : 13 MAVİ
 XX : 16 KIRMIZI
 XX : 11 SİYAH
 XX : 21 KAHVE
 XX : 15 YEŞİL

Kod Code	Ürün Tanımı	Description	Kutu Box	Birim Ağırlık/Hacim Unit Weight/Volume (gr)	Kutu Ağırlık/Hacim Box Weight/Volume (gr)
 065 094 OXX025	2,5 mm Ray Klemens Vidalı Tip	2,5 mm Screwed Terminal	100	7,014 / 0,00001334	701,40/ 0,00133
 065 094 OXX004	4 mm Ray Klemens Vidalı Tip	4 mm Screwed Terminal	100	8,658/ 0,00001795	865,80/ 0,00180
 065 094 OXX006	6 mm Ray Klemens Vidalı Tip	6mm Screwed Terminal	100	13,633 / 0,00001834	1363,30/ 0,00183
 065 094 OXX010	10 mm Ray Klemens Vidalı Tip	10 mm Screwed Terminal	100	17,706/0,00002412	1770,60/0,00241
 065 094 OXX016	16 mm Ray Klemens Vidalı Tip	16 mm Grey Screwed Terminal	50	24,62 / 0,00002790	1231,00/0,00140
 065 094 OXX035	35 mm Ray Klemens Vidalı Tip	35 mm Screwed Terminal	50	54,464/ 0,00005148	2723,20/0,00257
 065 094 OXX070	70 mm Ray Klemens Vidalı Tip	70 mm Screwed Terminal	20	98,46/ 0,00013163	1969,20/0,00263
 065 094 OXX095	95 mm Ray Klemens Vidalı Tip	95 mm Screwed Terminal	10	186,1/0,00022394	1861,00/0,00224

RAY KLEMENSLER VİDALI TİP • RAIL TERMINALS SCREWED TYPE

	Kod Code	Ürün Tanımı	Description	Kutu / Koli Box / Parcel	Birim Ağırlık/Hacim Unit Weight/Volume (gr)	Kutu Ağırlık/Hacim Box Weight/Volume (gr)
	065 094 0XX150	150 mm Ray Klemens Vidalı tip	150 mm Screwed Terminal	5	313/0,00070656	1565,00/0,00353
	065 094 0XX240	240 mm Ray Klemens Vidalı tip	240 mm Screwed Terminal	2	612,5/0,00128915	1225,00/0,00258
	065 094 4XX025	2,5 mm 1 Giriş 2 Çıkış Ray Klemens Vidalı Tip	2.5mm Single Input Double Output Screwed Terminal	100	11,45/ 0,00001492	1145,00/0,00149
	065 094 2XX025	2,5 mm 2 Giriş 2 Çıkış Ray Klemens Vidalı Tip	2.5mm Double Input Double Output Screwed Terminal	50	16,9/ 0,00002317	845,00/0,00116
	065 094 1XX025	2,5 mm Çift Katlı 2 Giriş 2 Çıkış Ray Klemens Vidalı Tip	2.5mm Double Layer Screwed Terminal	100	14,68/ 0,00002251	1468,00/0,00225
	065 094 1XX004	4 mm Çift Katlı 2 Giriş 2 Çıkış Ray Klemens Vidalı Tip	4 mm Screwed Terminal Double Layer	100	14,68/ 0,00002251	1468,00/ 0,00225
	065 094 2XX004	4 mm 2 Giriş 2 Çıkış Ray Klemens Vidalı Tip	4mm Double Input Double Output Screwed Terminal	50	16,9 / 0,00002317	845,00/ 0,00116

RAY KLEMENSLER VİDALI TOPRAKLAMA TİP • RAIL SCREWED TYPE GROUND TERMINALS

	Kod Code	Ürün Tanımı	Description	Kutu Box	Birim Ağırlık/Hacim Unit Weight/Volume (gr)	Kutu Ağırlık/Hacim Box Weight/Volume (gr)
	065 094 345025	2,5 mm Ray Klemens Topraklama Vidalı Tip Sarı-Yeşil	2,5mm Green-Yellow, Ground Terminal	50	9,4/ 0,00001330	470,00/0,00067
	065 094 345004	4 mm Ray Klemens Topraklama Vidalı Tip Sarı-Yeşil	4 mm Green-Yellow, Ground Terminal	50	10,89/ 0,00001330	544,50/0,00067
	065 094 345006	6 mm Ray Klemens Topraklama Vidalı Tip Sarı-Yeşil	6mm Green-Yellow, Ground Terminal	50	28,072/0,00002314	1403,60/0,00116
	065 094 345010	10 mm Ray Klemens Topraklama Vidalı Tip Sarı-Yeşil	10 mm Green-Yellow, Ground Terminal	50	36,465/0,00002900	1823,25/0,00145
	065 094 345016	16 mm Ray Klemens Topraklama Vidalı Tip Sarı-Yeşil	16 mm Green Yellow, Ground Terminal	50	41,3/0,00004206	2065,00/0,00210
	065 094 345035	35 mm Ray Klemens Topraklama Vidalı Tip Sarı-Yeşil	35 mm Green Yellow, Ground Terminal	20	101,4/ 0,00006747	2028,00/0,00135
	065 094 345070	70 mm Ray Klemens Topraklama Vidalı Tip Sarı-Yeşil	70 mm Green Yellow, Ground Terminal	20	152,75/ 0,00013163	3055,00/0,00263
	065 094 345095	95 mm Ray Klemens Topraklama Vidalı Tip Sarı-Yeşil	95 mm Green Yellow, Ground Terminal	20	152,75/ 0,00013163	3055,00/0,00263





RAY KLEMENSLER PUSH-İN TİP • RAIL TERMINALS PUSH-IN TYPE

	Kod Code	Ürün Tanımı	Description	Kutu Box	Birim Ağırlık/Hacim Unit Weight/Volume (gr)	Kutu Ağırlık/Hacim Box Weight/Volume (gr)
	065 095 0XX015	1,5 mm Ray Klemens Push-in Tip	1,5 mm Push-In Type Rail Terminal	100	4,264/ 0,00000708	426,40/0,00071
	065 095 0XX025	2,5 mm Ray Klemens Push-in Tip	2,5 mm Push-In Type Rail Terminal	100	6,416/ 0,00001075	641,60/0,00108
	065 095 0XX004	4 mm Ray Klemens Push-in Tip	4 mm Push-In Type Rail Terminal	100	8,73/ 0,00001476	873,00/0,00148
	065 095 0XX006	6 mm Ray Klemens Push-in Tip	6 mm Push-In Type Rail Terminal	100	17,36/ 0,00002352	1736,00/0,00235
	065 095 0XX010	10 mm Ray Klemens Push-in Tip	10 mm Push-In Type Rail Terminal	100	17,36/ 0,00002352	1736,00/0,00235
	065 095 4XX015	1,5 mm 1 Giriş 2 Çıkış Ray Klemens Push-in Tip	1,5 mm Single Input Double Output Push-In Type Rail Terminal	100	5,25/ 0,00000877	525,00/0,00088
	065 095 2XX015	1,5 mm 2 Giriş 2 Çıkış Ray Klemens Push-in Tip	1,5 mm Double Input Double Output Push-In Type Rail Terminal	100	5,131/ 0,00001012	513,10/0,00101
	065 095 4XX025	2,5 mm 1 Giriş 2 Çıkış Ray Klemens Push-in Tip	2,5 mm Single Input Double Output Push-In Type Rail Terminal	100	7,512/ 0,00001331	751,20/0,00133



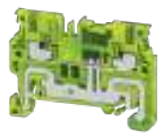

















RAY KLEMENSLER PUSH-İN TİP • RAIL TERMINALS PUSH-IN TYPE

	Kod Code	Ürün Tanımı	Description	Kutu Box	Birim Ağırlık/Hacim Unit Weight/Volume (gr)	Kutu Ağırlık/Hacim Box Weight/Volume (gr)
	065 095 2XX025	2,5 mm 2 Giriş 2 Çıkış Ray Klemens Push-İN Tip	2.5 mm Double Input Double Output Push-In Type Rail Terminal	100	9,65/ 0,00001577	965,00/0,00158
	065 095 1XX025	2,5 mm Çift Katlı 2 Giriş 2 Çıkış Ray Klemens Push-İN Tip	2.5 mm Double Layer Push-In Type Rail Terminal	50	11,26 /0,00002050	563,00/0,00103
	065 095 4XX004	4 mm 1 Giriş 2 Çıkış Ray Klemens Push-İN Tip	4 mm Single Input Double Output Rail Terminal	50	12,2/ 0,00001879	610,00/0,00094
	065 095 2XX004	4 mm 2 Giriş 2 Çıkış Ray Klemens Push-İN Tip	4 mm Double Input Double Output Rail Terminal	50	14,5/ 0,00002268	725,00/0,00113
	065 095 4XX006	6 mm 1 Giriş 2 Çıkış Ray Klemens Push-İN Tip	6 mm Single Input Double Output Rail Terminal	50	24,06/ 0,00003436	1203,00/0,00172
	065 095 4XX010	10 mm 1 Giriş 2 Çıkış Ray Klemens Push-İN Tip	10 mm Single Input Double Output Rail Terminal	50	24,06/ 0,00003436	1203,00/0,00172

RAY KLEMENSLER PUSH-İN TOPRAKLAMA TİP • RAIL TERMINALS GROUND PUSH-IN TYPE

	Kod Code	Ürün Tanımı	Description	Kutu Box	Birim Ağırlık/Hacim Unit Weight/Volume (gr)	Kutu Ağırlık/Hacim Box Weight/Volume (gr)
	065 095 345015	1,5 mm Ray Klemens Topraklama Vidalı Tip Sarı-Yeşil	1,5 mm Green Yellow, Ground Terminal	100	5,83/ 0,00000708	583,00/0,00071
	065 095 345025	2,5 mm Ray Klemens Topraklama Vidalı Tip Sarı-Yeşil	2,5 mm Green Yellow, Ground Terminal	100	7,854/ 0,00001075	785,40/0,00108
	065 095 345004	4 mm Ray Klemens Topraklama Vidalı Tip Sarı-Yeşil	4 mm Green Yellow, Ground Terminal	100	10,35/ 0,00001476	1035,00/0,00148
	065 095 345006	6 mm Ray Klemens Topraklama Vidalı Tip Sarı-Yeşil	6 mm Green Yellow, Ground Terminal	100	22,15/0,00002352	2215,00/0,00235
	065 095 345010	10 mm Ray Klemens Topraklama Vidalı Tip Sarı-Yeşil	10 mm Green Yellow, Ground Terminal	100	22,15/ 0,00002352	2215,00/0,00235

AKSESUARLAR • ACCESSORIES

	Kod Code	Ürün Tanımı Description	Kutu Box		Kod Code	Ürün Tanımı Description	Kutu Box
	065 096 000002	2,5-4 mm Vidalı Tip Kapak End Plate For Screwed Type 2,5-4 mm	50		065 096 000026	2,5 mm Üst Köprü Vidalı Tip 2'li 2 Pole Shorting Link for 2,5 mm	100
	065 096 000004	6-10 mm Vidalı Tip Kapak End Plate For Screwed Type 6-10 mm	50		065 096 000024	4 mm Üst Köprü Vidalı Tip 2'li 2 Pole Shorting Link for 4 mm	100
	065 096 000006	16 mm Vidalı Tip Kapak End Plate For Screwed Type 16 mm	50		065 096 000020	2,5 mm Üst Köprü Vidalı Tip 10'lu 10 Pole Shorting Link for 2,5 mm	10
	065 096 000008	2,5 mm Yan Kapak Vidalı Tip Çoklu End Plate For Double Screwed Type 2,5 mm	50		065 096 000022	4 mm Üst Köprü Vidalı Tip 10'lu 10 Pole Shorting Link for 4 mm	10
	065 096 000010	2,5 mm Yan Kapak Çift Katlı Vidalı End Plate For Screwed Double Layer 2,5 mm	50		065 096 000042	1,5 mm Dekafix Baskısız, Birleşik Kopan Combined Label Printless (for 1,5 mm terminal)	1
	065 096 000012	2,5mm - 4 mm Yan Kapak Push-in Tip End Plate For Push-In Type 2,5mm - 4 mm	50		065 096 000028	2,5 mm Dekafix Baskısız, Birleşik Kopan Combined Label Printless (for 2,5 mm terminal)	1
	065 096 000014	6-10 mm Yan Kapak Push-in Tip End Plate For Push-In Type 6-10 mm	50		065 096 000030	4 mm Dekafix Baskısız, Birleşik Kopan Combined Label Printless (for 4 mm terminal)	1
	065 096 000016	16 mm Yan Kapak Push-in Tip End Plate For Push-In Type 16 mm	50		065 096 000032	6 mm Dekafix Baskısız, Birleşik Kopan Combined Label Printless (for 6 mm terminal)	1
	065 096 000018	Durdurucu Stopper	50		065 096 000036	10 mm Dekafix Baskısız, Birleşik Kopan Combined Label Printless (for 10 mm terminal)	1
					065 096 000038	16 mm Dekafix Baskısız, Birleşik Kopan Combined Label Printless (for 16 mm terminal)	1
					065 096 000040	35-50 mm Dekafix Baskısız, Birleşik Kopan Combined Label Printless (for 35-50 mm terminal)	1

Promex

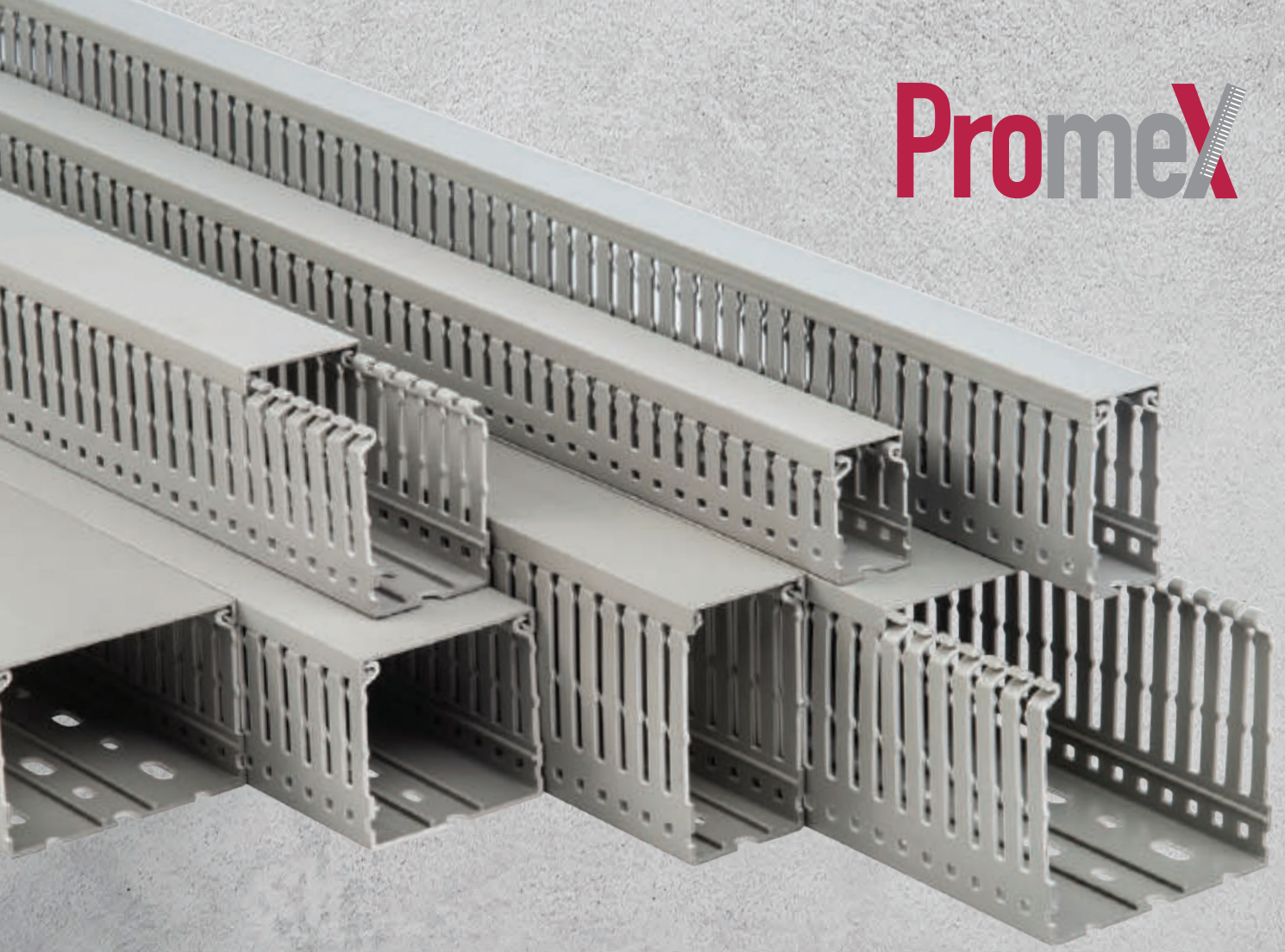

DELİKLİ KABLO KANALLARI SERİSİ
SLOTTED TRUNKING SERIES



@mutlusanelectric



@mutlusanelk



@mutlusanelektrik



@mutlusanplastikelektrik

Kanal tırnakları tabanın üst noktasından, herhangi bir el aletine gereksinim duymadan 90° bükülme sonucu kolayca kırılabilir. Side ribs can be broken easily from the upper part of trunking without using any tool.



Kanal yan duvarı, kolay kırılma çizgileri sayesinde tabana sıfır olarak çıkarılabilir. Side wall can be removed easily from the bottom level scorline.

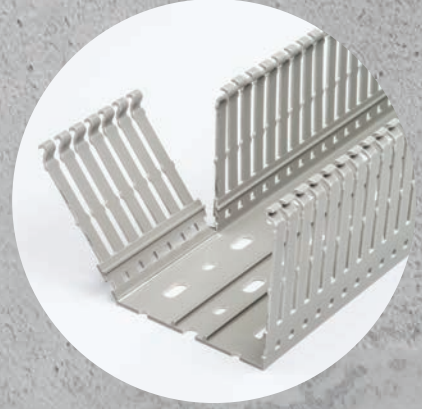

Özel tırnak tasarım yapısı ile kablolarınızı sıkıştırabilirsiniz. Kanal içindeki kabloların, kablo bağı ile bağlanmasına imkan veren delikleri sayesinde daha düzenli ve hızlı kablolama imkanına sahip olursunuz.

Especially designed ribs allow you to tight cables into trunking. You can make faster and stronger cabling through specially designed cable tie fixing slots.

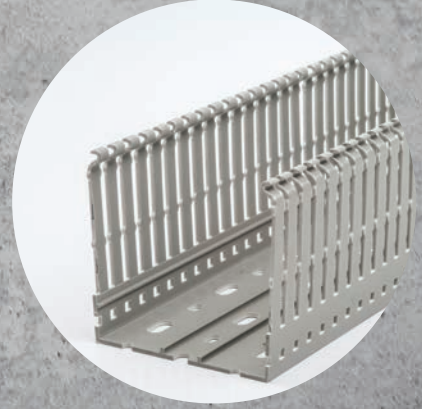

Özel kapak tasarımı, kanalın hangi konumda monte edildiğine bakılmaksızın kapağı kolayca monte edilmesini ve sökülmesini sağlar. Yoğun kablolamalarda bile kapağın kendinden çıkmasını engeller.

Strongly designed trunking cover allows you to assemble and disassemble it in any poistion of fixing. Cover will not come out even in case of mass cabling.

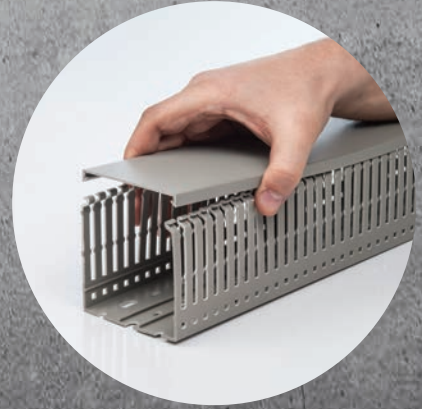

Promex

- UL94-V0 alev iletmez özelliğe sahip PVC
- hammaddeden imal,
- Slot aralığı 4/6/4 + 5/8/5 mm genişliğinde,
- Taban montaj delikleri DIN 43659 standartlarına uygun
- Standart kanal boyları 2 mt.
- EN 5085-2-3 standartlarına uygun,
- Her türlü sevkiyat ve depolama koşullarına dayanıklı özel karton ambalaj,
- Standart renk RAL 7030 (Gri), istek üzerine diğer renkler üretilebilir.
- Manufactured from PVC raw material with
- UL94-V0 flame retardant properties,
- Slot spacing 4/6/4 + 5/8/5 mm wide,
- Base mounting holes comply with DIN 43659 standards
- Standard channel lengths are 2 m.
- Complies with EN 5085-2-3 standards,
- Special cardboard packaging resistant to all types of shipping and storage conditions,
- Standard color RAL 7030 (Grey), other colors can be produced on request.

DELİKLİ KABLO KANALLARI SERİSİ SLOTTED TRUNKING SERIES



PROMEX SERİSİ DELİKLİ KABLO KANALLARI

PROMEX SERIES SLOTTED TRUNKING

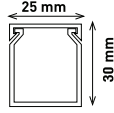

25X30

GRI GREY

Ürün Kodu	Product Code	001 105 025030 20 17
Ambalaj Şekli	Packing Type	Kutu - Box
Adet / m	Quantity / m	120 m
Slot Aralığı /mm	Slot Spacing (mm)	4/6/4
Ağırlık	Weight	29,4 kg
m ³	Volume	0,0934

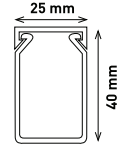

25X40

GRI GREY

Ürün Kodu	Product Code	001 105 025040 20 17
Ambalaj Şekli	Packing Type	Kutu - Box
Adet / m	Quantity / m	128 m
Slot Aralığı /mm	Slot Spacing (mm)	4/6/4
Ağırlık	Weight	36,352 kg
m ³	Volume	0,01216

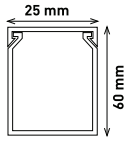

25X60

GRI GREY

Ürün Kodu	Product Code	001 105 025060 20 17
Ambalaj Şekli	Packing Type	Kutu - Box
Adet / m	Quantity / m	96 m
Slot Aralığı /mm	Slot Spacing (mm)	4/6/4
Ağırlık	Weight	33,504 kg
m ³	Volume	0,1216

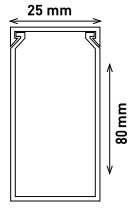

25X80

GRI GREY

Ürün Kodu	Product Code	001 105 025080 20 17
Ambalaj Şekli	Packing Type	Kutu - Box
Adet / m	Quantity / m	64 m
Slot Aralığı /mm	Slot Spacing (mm)	4/6/4
Ağırlık	Weight	26,752 kg
m ³	Volume	0,1216

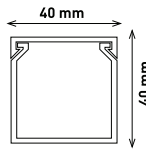

40X40

GRI GREY

Ürün Kodu	Product Code	001 105 040040 20 17
Ambalaj Şekli	Packing Type	Kutu - Box
Adet / m	Quantity / m	70 m
Slot Aralığı /mm	Slot Spacing (mm)	4/6/4
Ağırlık	Weight	26,32 kg
m ³	Volume	0,1216

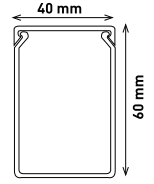

40X60

GRI GREY

Ürün Kodu	Product Code	001 105 040060 20 17
Ambalaj Şekli	Packing Type	Kutu - Box
Adet / m	Quantity / m	60 m
Slot Aralığı /mm	Slot Spacing (mm)	4/6/4
Ağırlık	Weight	28,2 kg
m ³	Volume	0,1216

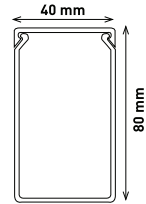
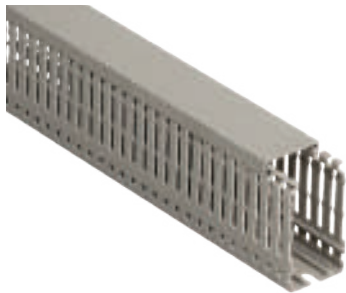

40X80

GRI GREY

Ürün Kodu	Product Code	001 105 040080 20 17
Ambalaj Şekli	Packing Type	Kutu - Box
Adet / m	Quantity / m	40 m
Slot Aralığı /mm	Slot Spacing (mm)	4/6/4
Ağırlık	Weight	23,0 kg
m ³	Volume	0,1216

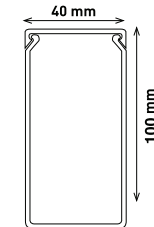
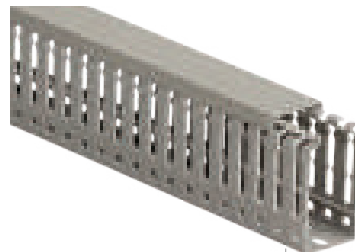

40X100

GRI GREY

Ürün Kodu	Product Code	001 105 040100 20 17
Ambalaj Şekli	Packing Type	Kutu - Box
Adet / m	Quantity / m	40 m
Slot Aralığı /mm	Slot Spacing (mm)	5/8/5
Ağırlık	Weight	26,6 kg
m ³	Volume	0,1216

PROMEX SERİSİ DELİKLİ KABLO KANALLARI

PROMEX SERIES SLOTTED TRUNKING

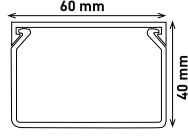

60X40

GRI GREY

Ürün Kodu	Product Code	001 105 060040 20 17
Ambalaj Şekli	Packing Type	Kutu - Box
Adet / m	Quantity / m	50 m
Slot Aralığı /mm	Slot Spacing (mm)	4/6/4
Ağırlık	Weight	24,8 kg
m ³	Volume	0,1216

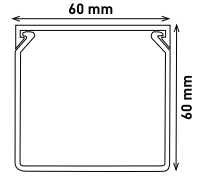

60X60

GRI GREY

Ürün Kodu	Product Code	001 105 060060 20 17
Ambalaj Şekli	Packing Type	Kutu - Box
Adet / m	Quantity / m	48 m
Slot Aralığı /mm	Slot Spacing (mm)	4/6/4
Ağırlık	Weight	29,18 kg
m ³	Volume	0,1216

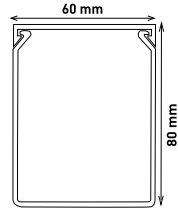
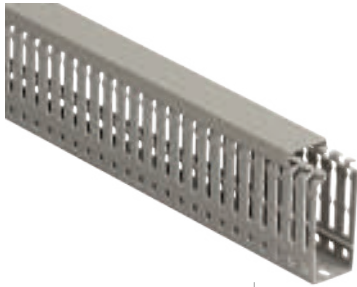

60X80

GRI GREY

Ürün Kodu	Product Code	001 105 060080 20 17
Ambalaj Şekli	Packing Type	Kutu - Box
Adet / m	Quantity / m	32 m
Slot Aralığı /mm	Slot Spacing (mm)	4/6/4
Ağırlık	Weight	22,91 kg
m ³	Volume	0,1216

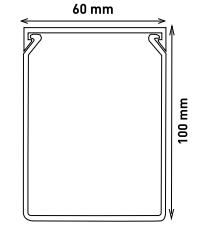
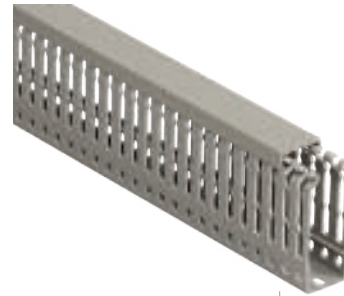

60X100

GRI GREY

Ürün Kodu	Product Code	001 105 060100 20 17
Ambalaj Şekli	Packing Type	Kutu - Box
Adet / m	Quantity / m	32 m
Slot Aralığı /mm	Slot Spacing (mm)	5/8/5
Ağırlık	Weight	25,47 kg
m ³	Volume	0,1216

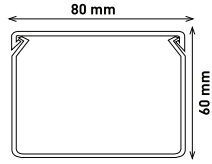
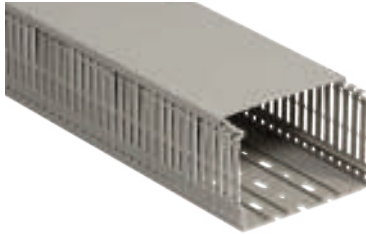

80X60

GRI GREY

Ürün Kodu	Product Code	001 105 080060 20 17
Ambalaj Şekli	Packing Type	Kutu - Box
Adet / m	Quantity / m	28 m
Slot Aralığı /mm	Slot Spacing (mm)	4/6/4
Ağırlık	Weight	20,27 kg
m ³	Volume	0,1216

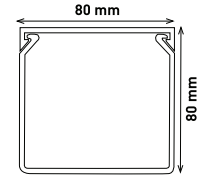

80X80

GRI GREY

Ürün Kodu	Product Code	001 105 080080 20 17
Ambalaj Şekli	Packing Type	Kutu - Box
Adet / m	Quantity / m	24 m
Slot Aralığı /mm	Slot Spacing (mm)	4/6/4
Ağırlık	Weight	19,8 kg
m ³	Volume	0,1216

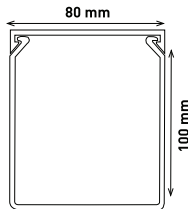

80X100

GRI GREY

Ürün Kodu	Product Code	001 105 080100 20 17
Ambalaj Şekli	Packing Type	Kutu - Box
Adet / m	Quantity / m	24 m
Slot Aralığı /mm	Slot Spacing (mm)	5/8/5
Ağırlık	Weight	22,68 kg
m ³	Volume	0,1216

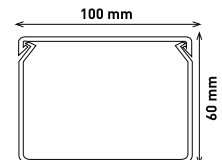
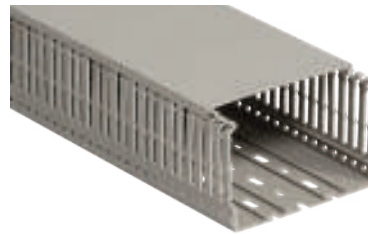

100X60

GRI GREY

Ürün Kodu	Product Code	001 105 100060 20 17
Ambalaj Şekli	Packing Type	Kutu - Box
Adet / m	Quantity / m	20 m
Slot Aralığı /mm	Slot Spacing (mm)	4/6/4
Ağırlık	Weight	18,0 kg
m ³	Volume	0,1216

PROMEX SERİSİ DELİKLİ KABLO KANALLARI

PROMEX SERIES SLOTTED TRUNKING

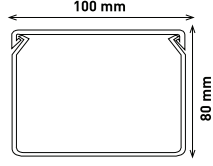
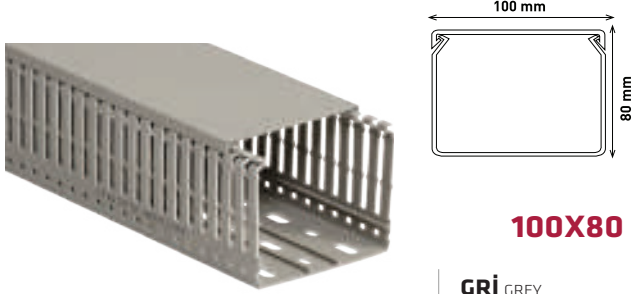

100X80

GRI GREY

Ürün Kodu	Product Code	001 105 100080 20 17
Ambalaj Şekli	Packing Type	Kutu - Box
Adet / m	Quantity / m	20 m
Slot Aralığı /mm	Slot Spacing (mm)	4/6/4
Ağırlık	Weight	20,4 kg
m ³	Volume	0,1216

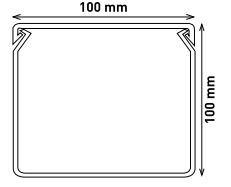
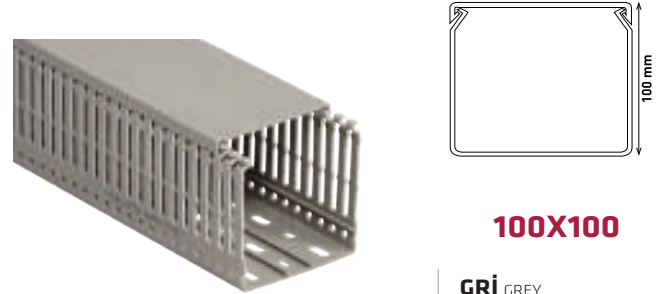

100X100

GRI GREY

Ürün Kodu	Product Code	001 105 100100 20 17
Ambalaj Şekli	Packing Type	Kutu - Box
Adet / m	Quantity / m	16 m
Slot Aralığı /mm	Slot Spacing (mm)	5/8/5
Ağırlık	Weight	17,49 kg
m ³	Volume	0,1216

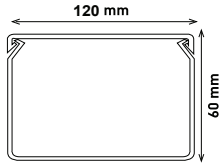
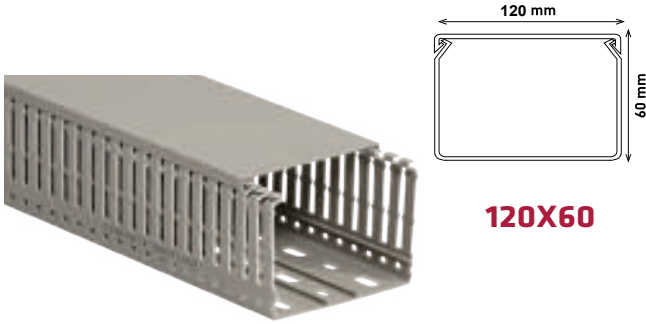

120X60

GRI GREY

Ürün Kodu	Product Code	001 105 120060 20 17
Ambalaj Şekli	Packing Type	Kutu - Box
Adet / m	Quantity / m	20 m
Slot Aralığı /mm	Slot Spacing (mm)	4/6/4
Ağırlık	Weight	20,8 kg
m ³	Volume	0,1216

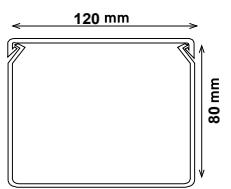
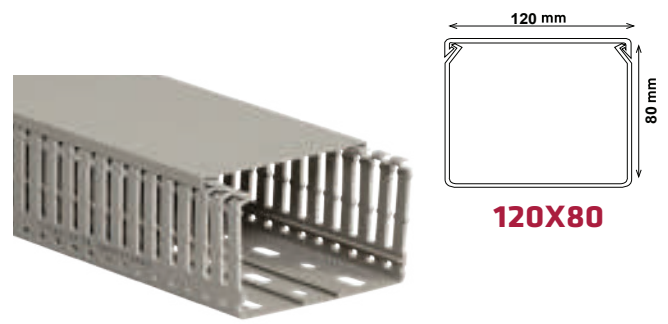

120X80

GRI GREY

Ürün Kodu	Product Code	001 105 120080 20 17
Ambalaj Şekli	Packing Type	Kutu - Box
Adet / m	Quantity / m	16 m
Slot Aralığı /mm	Slot Spacing (mm)	5/8/5
Ağırlık	Weight	25,47 kg
m ³	Volume	0,1216



MEKS SERİSİ DELİKLİ KABLO KANALLARI

MEKS SERIES SLOTTED TRUNKING

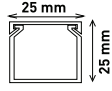
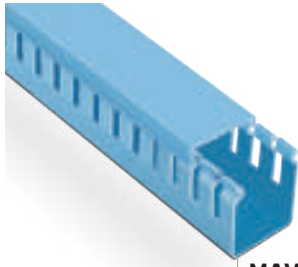

25X25

		MAVİ BLUE	BANTLI TAPPED
Ürün Kodu	Product Code	001 005 025025 20 13	001 008 025025 20 13
Ambalaj Şekli	Packing Type	Kutu - Box	Kutu - Box
Adet / m	Quantity / m	120 m	
Ağırlık	Weight	20,465 kg	
m ³	Volume	0,09272	

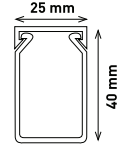
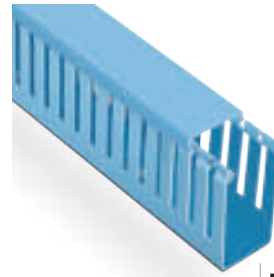

25X40

		MAVİ BLUE	BANTLI TAPPED
Ürün Kodu	Product Code	001 005 025040 20 13	001 008 025040 20 13
Ambalaj Şekli	Packing Type	Kutu - Box	Kutu - Box
Adet / m	Quantity / m	80 m	
Ağırlık	Weight	18,865 kg	
m ³	Volume	0,09272	

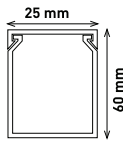

25X60

		MAVİ BLUE	BANTLI TAPPED
Ürün Kodu	Product Code	001 005 025060 20 13	001 008 025060 20 13
Ambalaj Şekli	Packing Type	Kutu - Box	Kutu - Box
Adet / m	Quantity / m	80 m	
Ağırlık	Weight	32,960 kg	
m ³	Volume	0,13392	

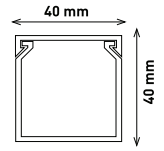
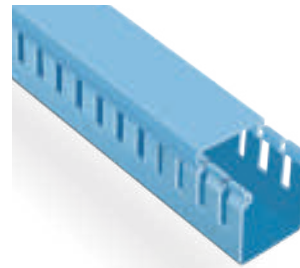

40X40

		MAVİ BLUE	BANTLI TAPPED
Ürün Kodu	Product Code	001 005 040040 20 13	001 008 040040 20 13
Ambalaj Şekli	Packing Type	Kutu - Box	Kutu - Box
Adet / m	Quantity / m	50 m	
Ağırlık	Weight	15,375 kg	
m ³	Volume	0,09272	

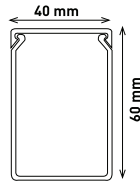

40X60

		MAVİ BLUE	BANTLI TAPPED
Ürün Kodu	Product Code	001 005 040060 20 13	001 008 040060 20 13
Ambalaj Şekli	Packing Type	Kutu - Box	Kutu - Box
Adet / m	Quantity / m	48 m	
Ağırlık	Weight	19,680 kg	
m ³	Volume	0,11029	

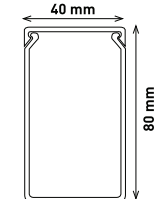

40X80

		MAVİ BLUE	BANTLI TAPPED
Ürün Kodu	Product Code	001 005 040080 20 13	001 008 040080 20 13
Ambalaj Şekli	Packing Type	Kutu - Box	Kutu - Box
Adet / m	Quantity / m	36 m	
Ağırlık	Weight	21,706 kg	
m ³	Volume	0,11029	

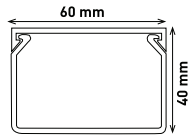
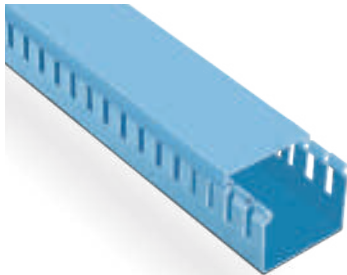

60X40

		MAVİ BLUE	BANTLI TAPPED
Ürün Kodu	Product Code	001 005 060040 20 13	001 008 060040 20 13
Ambalaj Şekli	Packing Type	Kutu - Box	Kutu - Box
Adet / m	Quantity / m	48 m	
Ağırlık	Weight	21,670 kg	
m ³	Volume	0,13392	

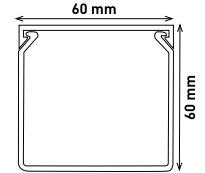
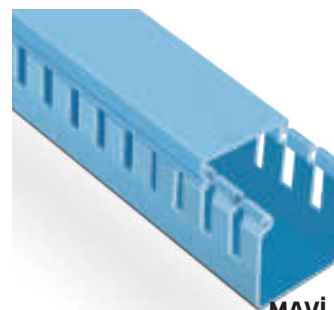

60X60

		MAVİ BLUE	BANTLI TAPPED
Ürün Kodu	Product Code	001 005 060060 20 13	001 008 060060 20 13
Ambalaj Şekli	Packing Type	Kutu - Box	Kutu - Box
Adet / m	Quantity / m	32 m	
Ağırlık	Weight	17,440 kg	
m ³	Volume	0,13392	

MEKS SERİSİ DELİKLİ KABLO KANALLARI

MEKS SERIES SLOTTED TRUNKING

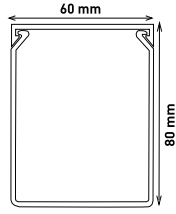

60X80

		MAVİ BLUE	BANTLI TAPPED
Ürün Kodu	Product Code	001 005 060080 20 13	001 008 060080 20 13
Ambalaj Şekli	Packing Type	Kutu - Box	Kutu - Box
Adet / m	Quantity / m	24 m	
Ağırlık	Weight	15,120 kg	
m ³	Volume	0,13392	

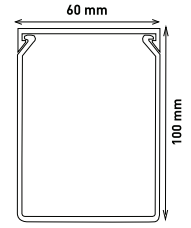
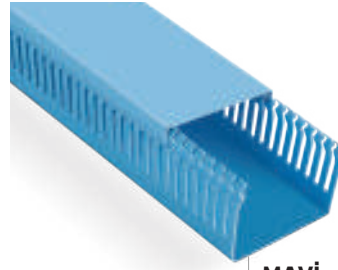

60X100

		MAVİ BLUE	BANTLI TAPPED
Ürün Kodu	Product Code	001 005 060100 20 13	001 008 060100 20 13
Ambalaj Şekli	Packing Type	Kutu - Box	Kutu - Box
Adet / m	Quantity / m	16 m	
Ağırlık	Weight	11,680 kg	
m ³	Volume	0,11029	

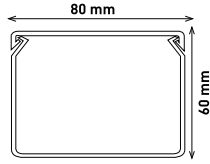
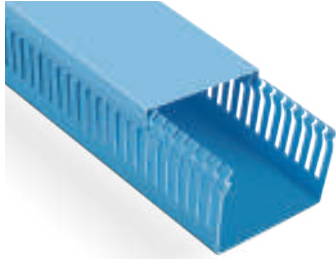

80X60

		MAVİ BLUE	BANTLI TAPPED
Ürün Kodu	Product Code	001 005 080060 20 13	001 008 080060 20 13
Ambalaj Şekli	Packing Type	Kutu - Box	Kutu - Box
Adet / m	Quantity / m	24 m	
Ağırlık	Weight	16,030 kg	
m ³	Volume	0,13392	

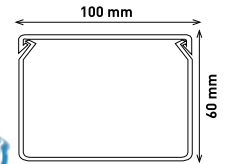
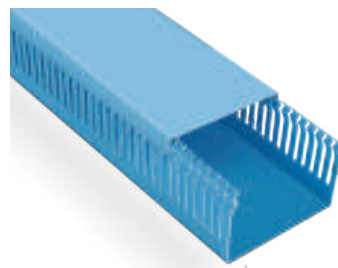

100X60

		MAVİ BLUE	BANTLI TAPPED
Ürün Kodu	Product Code	001 005 100060 20 13	001 008 100060 20 13
Ambalaj Şekli	Packing Type	Kutu - Box	Kutu - Box
Adet / m	Quantity / m	16 m	
Ağırlık	Weight	13,590 kg	
m ³	Volume	0,11029	

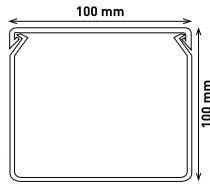
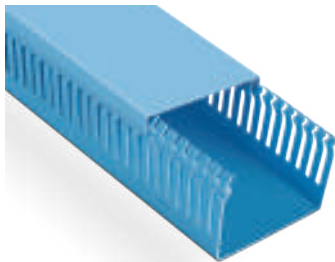

100X100

		MAVİ BLUE	BANTLI TAPPED
Ürün Kodu	Product Code	001 005 100100 20 13	001 008 100100 20 13
Ambalaj Şekli	Packing Type	Kutu - Box	Kutu - Box
Adet / m	Quantity / m	8 m	
Ağırlık	Weight	10,622 kg	
m ³	Volume	0,11029	

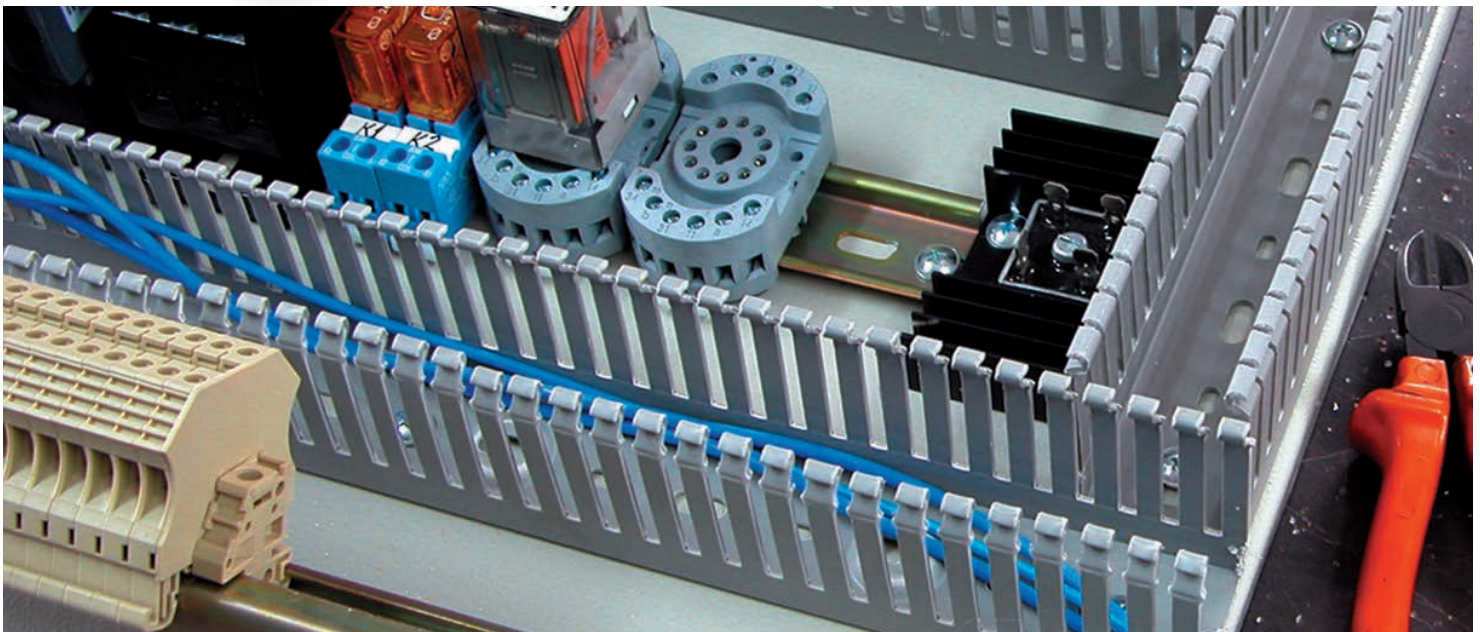

MEKS SERİSİ DELİKLİ KABLO KANALLARI

MEKS SERIES SLOTTED TRUNKING

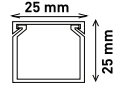

25X25

		GRI GREY	BANTLI TAPPED
Ürün Kodu	Product Code	001 005 025025 20 17	001 008 025025 20 17
Ambalaj Şekli	Packing Type	Kutu - Box	Kutu - Box
Adet / m	Quantity / m	120 m	
Ağırlık	Weight	20,465 kg	
m ³	Volume	0,09272	

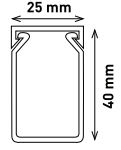

25X40

		GRI GREY	BANTLI TAPPED
Ürün Kodu	Product Code	001 005 025040 20 17	001 008 025040 20 17
Ambalaj Şekli	Packing Type	Kutu - Box	Kutu - Box
Adet / m	Quantity / m	80 m	
Ağırlık	Weight	18,864 kg	
m ³	Volume	0,09272	

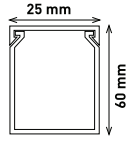

25X60

		GRI GREY	BANTLI TAPPED
Ürün Kodu	Product Code	001 005 025060 20 17	001 008 025060 20 17
Ambalaj Şekli	Packing Type	Kutu - Box	Kutu - Box
Adet / m	Quantity / m	80 m	
Ağırlık	Weight	32,960 kg	
m ³	Volume	0,13392	

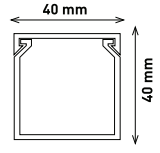

40X40

		GRI GREY	BANTLI TAPPED
Ürün Kodu	Product Code	001 005 040040 20 17	001 008 040040 20 17
Ambalaj Şekli	Packing Type	Kutu - Box	Kutu - Box
Adet / m	Quantity / m	50 m	
Ağırlık	Weight	15,375 kg	
m ³	Volume	0,09272	

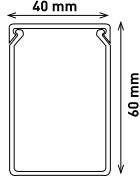
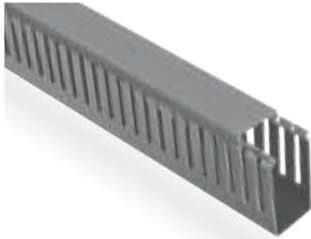

40X60

		GRI GREY	BANTLI TAPPED
Ürün Kodu	Product Code	001 005 040060 20 17	001 005 040060 20 17
Ambalaj Şekli	Packing Type	Kutu - Box	Kutu - Box
Adet / m	Quantity / m	48 m	
Ağırlık	Weight	19,680 kg	
m ³	Volume	0,13392	

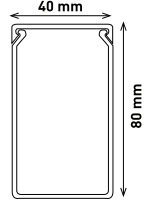

40X80

		GRI GREY	BANTLI TAPPED
Ürün Kodu	Product Code	001 005 040080 20 17	001 005 040080 20 17
Ambalaj Şekli	Packing Type	Kutu - Box	Kutu - Box
Adet / m	Quantity / m	36 m	
Ağırlık	Weight	21,706 kg	
m ³	Volume	0,13392	

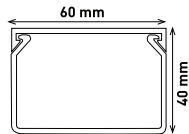
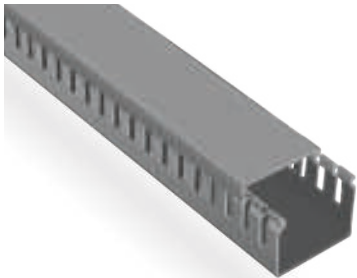

60X40

		GRI GREY	BANTLI TAPPED
Ürün Kodu	Product Code	001 005 060040 20 17	001 005 060040 20 17
Ambalaj Şekli	Packing Type	Kutu - Box	Kutu - Box
Adet / m	Quantity / m	48 m	
Ağırlık	Weight	21,672 kg	
m ³	Volume	0,13392	

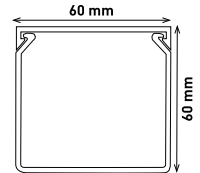

60X60

		GRI GREY	BANTLI TAPPED
Ürün Kodu	Product Code	001 005 060060 20 17	001 005 060060 20 17
Ambalaj Şekli	Packing Type	Kutu - Box	Kutu - Box
Adet / m	Quantity / m	32 m	
Ağırlık	Weight	178,440 kg	
m ³	Volume	0,13392	

MEKS SERİSİ DELİKLİ KABLO KANALLARI

MEKS SERIES SLOTTED TRUNKING

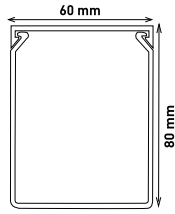

60X80

		GRI GREY	BANTLI TAPPED
Ürün Kodu	Product Code	001 005 060080 20 17	001 005 060080 20 17
Ambalaj Şekli	Packing Type	Kutu - Box	Kutu - Box
Adet / m	Quantity / m	24 m	
Ağırlık	Weight	15,120 kg	
m ³	Volume	0,13392	

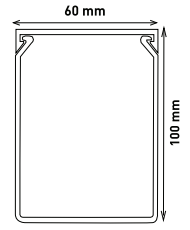

60X100

		GRI GREY	BANTLI TAPPED
Ürün Kodu	Product Code	001 005 060100 20 17	001 005 060100 20 17
Ambalaj Şekli	Packing Type	Kutu - Box	Kutu - Box
Adet / m	Quantity / m	16 m	
Ağırlık	Weight	11,680 kg	
m ³	Volume	0,11029	

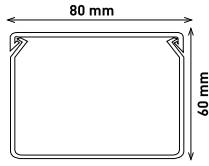
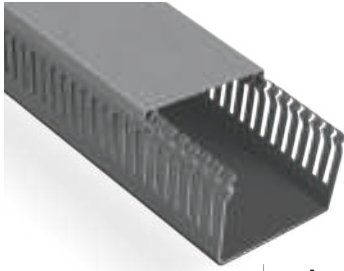

80X60

		GRI GREY	BANTLI TAPPED
Ürün Kodu	Product Code	001 005 080060 20 17	001 005 080060 20 17
Ambalaj Şekli	Packing Type	Kutu - Box	Kutu - Box
Adet / m	Quantity / m	24 m	
Ağırlık	Weight	16,030 kg	
m ³	Volume	0,13392	

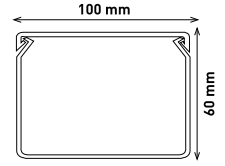
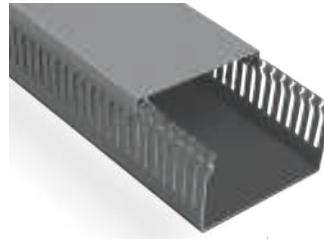

100X60

		GRI GREY	BANTLI TAPPED
Ürün Kodu	Product Code	001 005 100060 20 17	001 005 100060 20 17
Ambalaj Şekli	Packing Type	Kutu - Box	Kutu - Box
Adet / m	Quantity / m	16 m	
Ağırlık	Weight	13,590 kg	
m ³	Volume	0,11029	

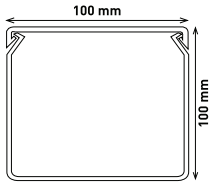
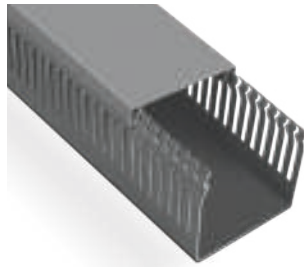

100X100

		GRI GREY	BANTLI TAPPED
Ürün Kodu	Product Code	001 005 100100 20 17	001 005 100100 20 17
Ambalaj Şekli	Packing Type	Kutu - Box	Kutu - Box
Adet / m	Quantity / m	8 m	
Ağırlık	Weight	10,622 kg	
m ³	Volume	0,11029	

Kablo Tutucu Aparatı
Cable Holder Apparatus

		25x40	40x40	60x40
Ürün Kodu	Product Code	001 050 010001 00 00	001 050 010002 00 00	001 050 010003 00 00
Ambalaj Şekli	Packing Type	Kutu - Box	Kutu - Box	Kutu - Box
Adet / m	Quantity / m	-	40 m	50 m
Ağırlık	Weight	-	0,395 kg	0,445 kg
m ³	Volume	-	-	0,00400

Kablo Tutucu Yan Aparatı
Cable Holder Side Apparatus

		40x40/60	60x40/60	80x60	100x60
Ürün Kodu	Product Code	001 050 020001 00 00	001 050 020002 00 00	001 050 020003 00 00	001 050 020004 00 00
Ambalaj Şekli	Packing Type	Kutu - Box	Kutu - Box	Kutu - Box	Kutu - Box
Adet / m	Quantity / m	100 m	100 m	100 m	100 m
Ağırlık	Weight	0,270 kg	0,210 kg	0,260 kg	0,340 kg
m ³	Volume	0,00139	0,00160	0,00300	0,00300

PANOLAR ve AKSESUARLARI

PANELS and ACCESORIES

Zorlu Şartlara
Karşı Güvenli Panolar.

Safe Boards Against Harsh Conditions.



PLASTİK OPAK KAPAKLI PANOLAR
PLASTIC PANELS WITH OPAQUE LID



KOD CODE	ÖLÇÜ DIMENSION	AMBALAJ PACKING	ADET QUANTITY	AĞIRLIK WEIGHT	HACİM VOLUME
001 046 203013 00 17	20x30x13	KUTU PACK	1	1,684 kg	0,0084
001 046 253515 00 17	25x35x15	KUTU PACK	1	2,359 kg	0,0140
001 046 304017 00 17	30x40x17	KUTU PACK	1	3,076 kg	0,0216
001 046 304022 00 17	30x40x22	KUTU PACK	1	3,475 kg	0,0276
001 046 355019 00 17	35x50x19	KUTU PACK	1	4,306 kg	0,0350
001 046 405018 00 17	40x50x18	KUTU PACK	1	4,456 kg	0,0454
001 046 405024 00 17	40x50x24	KUTU PACK	1	5,546 kg	0,0501
001 046 406020 00 17	40x60x20	KUTU PACK	1	5,779 kg	0,0508
001 046 507025 00 17	50x70x25	KUTU PACK	1	9,502 kg	0,0908
001 046 608026 00 17	60x80x26	KUTU PACK	1	13,39 kg	0,1299

PLASTİK ŞEFFAF KAPAKLI PANOLAR
PLASTIC PANELS WITH TRANSPARENT LID



KOD CODE	ÖLÇÜ DIMENSION	AMBALAJ PACKING	ADET QUANTITY	AĞIRLIK WEIGHT	HACİM VOLUME
001 046 203013 00 44	20x30x13	KUTU PACK	1	1,715 kg	0,0084
001 046 253515 00 44	25x35x15	KUTU PACK	1	2,359 kg	0,0140
001 046 304017 00 44	30x40x17	KUTU PACK	1	3,170 kg	0,0216
001 046 304022 00 44	30x40x22	KUTU PACK	1	3,455 kg	0,0278
001 046 355019 00 44	35x50x19	KUTU PACK	1	4,356 kg	0,0350
001 046 405018 00 44	40x50x18	KUTU PACK	1	4,628 kg	0,0454
001 046 405024 00 44	40x50x24	KUTU PACK	1	4,736 kg	0,0501
001 046 406020 00 44	40x60x20	KUTU PACK	1	6,004 kg	0,0502
001 046 507025 00 44	50x70x25	KUTU PACK	1	9,827 kg	0,0908
001 046 608026 00 44	60x80x26	KUTU PACK	1	13,725 kg	0,1299

OPA KAPAKLI ABS OTOMAT PANOLAR
OPAQUE COVERED ABS FUSE PANELS



KOD CODE	ÖLÇÜ DIMENSION	AÇIKLAMA DESCRIPTION	AMBALAJ PACKING	ADET QUANTITY	AĞIRLIK WEIGHT	HACİM VOLUME
001 046 253515 01 17	25x35x15	18 OTOMATLI 18 FUSE(9X2)	KUTU PACK	1	8,50 kg	0,0140
001 046 304017 01 17	30x40x17	24 OTOMATLI 24 FUSE(12X2)	KUTU PACK	1	8,50 kg	0,0216
001 046 355019 01 17	35x50x19	45 OTOMATLI 45 FUSE(15X3)	KUTU PACK	1	8,50 kg	0,0350
001 046 406020 01 17	40x60x20	60 OTOMATLI 60 FUSE(15X4)	KUTU PACK	1	8,50 kg	0,0502

ŞEFFAF KAPAKLI ABS OTOMAT PANOLAR
TRANSPARENT PANELS WITH OPAQUE LID



KOD CODE	ÖLÇÜ DIMENSION	AÇIKLAMA DESCRIPTION	AMBALAJ PACKING	ADET QUANTITY	AĞIRLIK WEIGHT	HACİM VOLUME
001 046 253515 01 44	25x35x15	18 OTOMATLI 18 FUSE(9X2)	KUTU PACK	1	8,50 kg	0,0140
001 046 304017 01 44	30x40x17	24 OTOMATLI 24 FUSE(12X2)	KUTU PACK	1	8,50 kg	0,0216
001 046 355019 01 44	35x50x19	45 OTOMATLI 45 FUSE(15X3)	KUTU PACK	1	8,50 kg	0,0350
001 046 406020 01 44	40x60x20	60 OTOMATLI 60 FUSE(15X4)	KUTU PACK	1	8,50 kg	0,0502

PANO AKSESUARLARI PANEL ACCESSORIES



GALVANİZ TABAN SAÇLARI GALVANIZED BASE SHEETS

KOD CODE	ÖLÇÜ DIMENSION	KALINLIK PRODUCT THICKNESS	AMBALAJ PACKING	ADET QUANTITY
000 702 203013 00 00	20x30x13	1 mm	KUTU PACK	1
000 702 253515 00 00	25x35x15	1 mm	KUTU PACK	1
000 702 304017 00 00	30x40x17	1 mm	KUTU PACK	1
000 702 304022 00 00	30x40x22	1 mm	KUTU PACK	1
000 702 355019 00 00	35x50x19	1 mm	KUTU PACK	1
000 702 405018 00 00	40x50x17,5	1 mm	KUTU PACK	1
000 702 405024 00 00	40x50x24	1 mm	KUTU PACK	1
000 702 406020 00 00	40x60x20	1 mm	KUTU PACK	1
000 702 507025 00 00	50x70x25	1 mm	KUTU PACK	1



MODULER KİTLER ve SEPERATÖRLER MODULAR KITS AND SEPERATORS

KOD CODE	ÖLÇÜ DIMENSION	AÇIKLAMA DESCRIPTION	AĞIRLIK WEIGHT	HACİM VOLUME
000 700 253515 01 17	25x35x15	18 OTOMATLI 18 FUSE (9X2)	1,715 kg	0,0084
000 700 304017 01 17	30x40x17	24 OTOMATLI 24 FUSE (9X2)	2,359 kg	0,0140
000 700 355019 01 17	35x50x19	45 OTOMATLI 45 FUSE (15X3)	3,170 kg	0,0216
000 700 406020 01 17	40x60x20	60 OTOMATLI 60 FUSE (15X4)	3,455 kg	0,0278
000 700 253515 00 17	35x35x15	PLASTİK PERDE PLASTIC COVER	4,356 kg	0,0350
000 700 304017 00 17	30x40x17	PLASTİK PERDE PLASTIC COVER	4,628 kg	0,0454
000 700 355019 00 17	35x50x19	PLASTİK PERDE PLASTIC COVER	4,736 kg	0,0501
000 700 406020 00 17	40x60x20	PLASTİK PERDE PLASTIC COVER	6,004 kg	0,0502

PANO AKSESUARLARI PANEL ACCESSORIES



KOD CODE	AÇIKLAMA DESCRIPTION	AMBALAJ PACKING	ADET QUANTITY
000 705 000720 00 00	PANO KİLİT GÖBEK TAKIMI (SET) LOCK CYLINDER KIT	KUTU PACK	1



000 700 000710 00 17	PANO DUVAR MONTAJ APARATI PANEL WALL MOUNTING APPARATUS (4 SET)	KUTU PACK	1
----------------------	--	-----------	---



000 700 000711 00 17	PLASTİK PANO ÜÇGEN ANAHTAR PLASTIC TRIANGLE KEY	KUTU PACK	1
----------------------	--	-----------	---



000 700 000712 00 17	PANO SEPERATÖRÜ TUTTURMA VİDASI PANEL SEPERATOR HOLDING SCREW	KUTU PACK	1
----------------------	--	-----------	---



000 705 000721 00 00	PLASTİK KİLİTLENEBİLİR PANO (METAL) KİLİDİ PLASTIC LOCKABLE PANEL LOCK	KUTU PACK	1
----------------------	---	-----------	---

RAY TİPİ PANO PRİZİ RAIL TYPE PANEL SOCKET



KOD CODE	AÇIKLAMA DESCRIPTION	AMBALAJ PACKING	ADET QUANTITY	AĞIRLIK WEIGHT	HACİM VOLUME
010 104 000157	MRP-16 1X16 RAY TİPİ PANO PRİZİ MRP-16 1X16 RAIL TYPE PANEL SOCKET	KUTU PACK	10	890,1 gr	0,0201



010 104 000158	MRP-LED 10X16 RAY TİPİ PANO PRİZİ-LEDLİ MRP-LED 10X16 RAIL TYPE PANEL SOCKET LED	KUTU PACK	10	890,1 gr	0,0201
----------------	--	-----------	----	----------	--------



010 104 000159	MRP-UPS 1X16 RAY TİPİ PANO PRİZİ-UPS MRP-UPS 1X16 RAIL TYPE PANEL SOCKET UPS	KUTU PACK	10	890,1 gr	0,0201
----------------	---	-----------	----	----------	--------

DİJİTAL TERMOSTAT VE HİGROSTAT

DIGITAL THERMOSTAT AND HYGROSTAT



ENERJİ TASARRUFU

Doğru sıcaklık değerini korumak için ısıtma veya soğutma cihazlarını açıp kapatarak veya bir ısı transfer sıvısının akışını gerektiği gibi düzenleyerek kontrol yapar.

ENERGY SAVINGS

It controls heating or cooling devices by turning them on and off or by regulating the flow of a heat transfer fluid as necessary to maintain the correct temperature value.

KOD / CODE: 048 095 000304

PDT 50-150 SICAKLIK KONTROL CİHAZI

PDT 50-150 TEMPERATURE CONTROL DEVICE

ÖLÇÜLER DIMENSIONS	36x90x65 RAYA MONTAJ RAIL MOUNTING
GÖSTERGE INDICATOR	3 HANE 7 SEGMENT 3 DIGIT 7 SEGMENT
SENSÖR SENSOR	PTC
ÖLÇME SKALASI MEASURING SCALE	-50...+150°C
DUYARLILIK SENSITIVITY	±C
DOĞRULUK ACCURACY	%1 (TAM SKALANIN) (FULL SCALE)
KONTROL DURUMU CONTROL STATUS	ON-OFF
OUT ÇIKIŞI OUTPUT	RÖLE, 250V AC, 2A, REZİSTİF YÜK RESISTIVE LOAD
ALARM ÇIKIŞI ALARM OUTPUT	RÖLE, 250V AC, 2A, REZİSTİF YÜK RESISTIVE LOAD
HEAT SET AYARI HEAT SETTING	LoL... UPL C (Hst)
ALARM SET AYARI ALARM SETTING	AtP=Abs,-Ab;LoL...C (Ast) AtP=rEL, -rL; (HSt+rAL),(HSt-20)...(Hst+20) C
HEAT HİSTERESİZ HEAT HYSTERESIS	1...20 C (Hhs)
ALARM HİSTERESİZ ALARM HYSTERESIS	1...20 C (Hhs)
OFFSET OFFSET	-20...+20°C
ISITMA-SOĞUTMA HEATING COOLING	H-C;Ht (ISITMA-HEATING);CL SOĞUTMA-COOLING); SEÇMELİ-OPTIONAL
BESLEME VOLTAJ SUPPLY VOLTAGE	100...240V AC, 50/60 Hz
GÜÇ TÜKETİMİ POWER CONSUMPTION	≤6VA
ÇALIŞMA SICAKLIĞI OPERATING TEMP.	-20 °C...55 °C
İŞLETME İRTİFASI OPERATING ALTITUDE	≤2000m
ADET QUANTITY	1

NOT: PTC SENSÖR CİHAZ DAHİLİNDEDİR.

NOTE: PTC SENSOR IS INCLUDED IN THE DEVICE.

KOD / CODE: 048 095 000305

HT-310 SICAKLIK VE NEM KONTROL CİHAZI

HT-310 TEMPERATURE AND MOISTURE CONTROLLER

ÖLÇÜLER DIMENSIONS	35x77mm RAYA MONTAJ RAIL MOUNTING
GÖSTERGE INDICATOR	3 HANE 7 SEGMENT 3 DIGIT 7 SEGMENT
SENSÖR SENSOR	DİJİTAL SICAKLIK NEM SENSÖRÜ DIGITAL TEMPERATURE HUMIDITY SENSOR
ÖLÇME SKALASI MEASURING SCALE	-19,9...+80,0C, 5...95%RH
DUYARLILIK SENSITIVITY	±C0, C, ± 1%RH
DOĞRULUK ACCURACY	± %1(C), ± %3 (%RH)(TAM SKALANIN FULL SCALE)
KONTROL DURUMU CONTROL STATUS	ON-OFF
C OUT ÇIKIŞI C OUTPUT	RÖLE, (NA+NK), 250V AC, 2A REZİSTİF YÜK RESISTIVE LOAD
%RH OUT ÇIKIŞI %RH OUTPUT	RÖLE, (NA), 250V AC, 2A REZİSTİF YÜK RESISTIVE LOAD
ISITMA-SOĞUTMA HEATING-COOLING	(ISITMA-HEATING), CL SOĞUTMA COOLING-SEÇMELİ OPTIONAL
BESLEME VOLTAJ SUPPLY VOLTAGE	100...220V AC, 50/60 Hz
GÜÇ TÜKETİMİ POWER CONSUMPTION	≤ 6VA
ÇALIŞMA SICAKLIĞI OPERATING TEMP	0°C...55°C
İŞLETME İRTİFASI OPERATING ALTITUDE	≤ 2000m
ADET QUANTITY	1











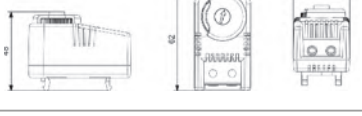

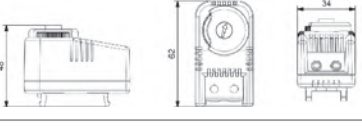

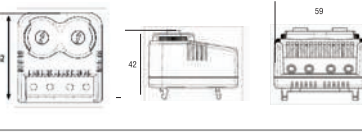

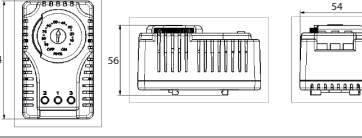
NOT: SICAKLIK VE NEM SENSÖRÜ CİHAZ DAHİLİNDEDİR.

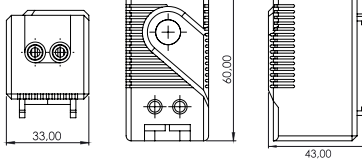
NOTE: TEMPERATURE AND HUMIDITY SENSOR IS INCLUDED IN THE DEVICE

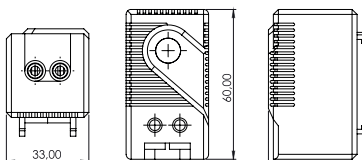

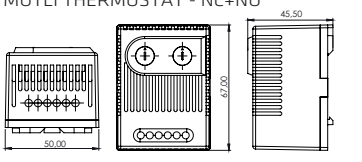
TERMOSTAT VE HİGROSTAT

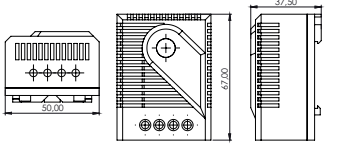
THERMOSTAT AND HYGROSTAT

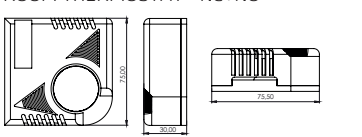
		AÇIKLAMA DESCRIPTION	AMBALAJ PACKING	ADET QUANTITY	AĞIRLIK WEIGHT
	ISITICI TERMOSTAT HEATING THERMOSTAT - NC 	048 095 000300 AYAR SAHASI SETTING FIELD 0-60°C KONTAK TIPI CONTACT TYPE NC KORUMA SINIFI PROTECTED CLASS IP20	KUTU PACK	1	45 gr
	SOĞUTUCU TERMOSTAT COOLING THERMOSTAT - NO 	048 095 000301 AYAR SAHASI SETTING FIELD 0-60°C KONTAK TIPI CONTACT TYPE NO KORUMA SINIFI PROTECTED CLASS IP20	KUTU PACK	1	45 gr
	DUAL TERMOSTAT DUAL THERMOSTAT - NC+NO 	048 095 000302 AYAR SAHASI SETTING FIELD 0-60°C KONTAK TIPI CONTACT TYPE NC+NO KORUMA SINIFI PROTECTED CLASS IP20	KUTU PACK	1	80 gr
	MEKANİK HİGROSTAT MECHANICAL HYGROSTAT - NC+NO 	048 095 000303 AYAR SAHASI SETTING FIELD %10-90RH KONTAK TIPI CONTACT TYPE NC+NO KORUMA SINIFI PROTECTED CLASS IP20	KUTU PACK	1	180 gr
	SOĞUTUCU TERMOSTAT COOLING THERMOSTAT - NO 	048 095 101141 AYAR SAHASI SETTING FIELD 0-60°C KONTAK TIPI CONTACT TYPE NO KORUMA SINIFI PROTECTED CLASS IP20	KUTU PACK	1	45 gr
	ISITICI TERMOSTAT HEATING THERMOSTAT - NC 	048 095 101140 AYAR SAHASI SETTING FIELD 0-60°C KONTAK TIPI CONTACT TYPE NC KORUMA SINIFI PROTECTED CLASS IP20	KUTU PACK	1	45 gr
	MULTİ TERMOSTAT MUTLI THERMOSTAT - NC+NO 	048 095 101142 AYAR SAHASI SETTING FIELD 0-60°C KONTAK TIPI CONTACT TYPE NC+NO KORUMA SINIFI PROTECTED CLASS IP20	KUTU PACK	1	80 gr
	HİGROSTAT HIGROSTAT - NC+NO 	048 095 101143 AYAR SAHASI SETTING FIELD %40 -90 RH KONTAK TIPI CONTACT TYPE NC+NO KORUMA SINIFI PROTECTED CLASS IP20	KUTU PACK	1	180 gr
	ODA TERMOSTATI ROOM THERMOSTAT - NC+NO 	048 095 101144 AYAR SAHASI SETTING FIELD 0-60°C KONTAK TIPI CONTACT TYPE NC+NO KORUMA SINIFI PROTECTED CLASS IP20	KUTU PACK	1	80 gr

TEPE FANLARI

ROOF FANS

PROMEX SERİSİ / PROMEX SERIES

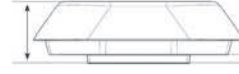
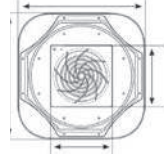

KOD CODE	FAN TİPİ FAN TYPE	BESLEME POWER SUPPLY	GÜÇ/WATT (W)	NOMINAL AKIM NOMINAL CURRENT	GÜRÜLTÜ SEVİYESİ NOISE LEVEL	KAPASİTE CAPACITY	ADET QUANTITY
048 095 000100	Ø172x163x51 AKSİYEL / AXIAL	220V AC 50/60 Hz	25/32W	0,11/0,15A	57 dB	400 m ³ / h	1
048 095 000101	Ø190x68 RADYAL / RADIAL	220V AC 50/60 Hz	58/75W	0,26/0,34A	62 dB	560 m ³ / h	1
048 095 000102	Ø220x71 RADYAL / RADIAL	220V AC 50/60 Hz	85/90W	0,38/0,44A	73 dB	970 m ³ / h	1

PROMEX SERİSİ / PROMEX SERIES

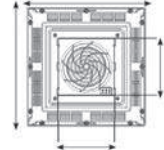

Vidasız ve Kolay Montaj
Fast and easy assembly without screws

KOD CODE	FAN TİPİ FAN TYPE	BESLEME POWER SUPPLY	GÜÇ/WATT (W)	NOMINAL AKIM NOMINAL CURRENT	GÜRÜLTÜ SEVİYESİ NOISE LEVEL	KAPASİTE CAPACITY	ADET QUANTITY
048 095 000200	Ø172x163x51 AKSİYEL / AXIAL	220V AC 50/60 Hz	25/32W	0,11/0,15A	57 dB	400 m ³ / h	1
048 095 000201	Ø190x68 RADYAL / RADIAL	220V AC 50/60 Hz	58/75W	0,26/0,34A	62 dB	560 m ³ / h	1
048 095 000202	Ø220x71 RADYAL / RADIAL	220V AC 50/60 Hz	85/90W	0,38/0,44A	73 dB	970 m ³ / h	1

EKOFAN SERİSİ / EKOFAN SERIES

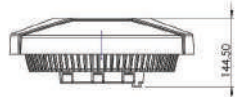

**YENİ
NEW**

KOD CODE	FAN TİPİ FAN TYPE	BESLEME POWER SUPPLY	GÜÇ/WATT (W)	NOMINAL AKIM NOMINAL CURRENT	GÜRÜLTÜ SEVİYESİ NOISE LEVEL	KAPASİTE CAPACITY	ADET QUANTITY
048 095 100100	Ø172x163x51 AKSİYEL / AXIAL	230V AC 50/60 Hz	35W	0,11/0,15A	51 dB	400 m ³ / h	1
048 095 100101	Ø190x68 RADYAL / RADIAL	230V AC 50/60 Hz	65W	0,26/0,30A	60 dB	560 m ³ / h	1
048 095 100102	Ø220x71 RADYAL / RADIAL	230V AC 50/60 Hz	90W	0,38/0,44A	60 dB	970 m ³ / h	1
048 095 100103	Ø220x71 RADYAL / RADIAL	230V AC 50/60 Hz	90W	0,38/0,44A	90 dB	970 m ³ / h	1

KOLAY MONTAJ FİLTRELER

EASY MOUNTING FILTERS



Ürün Kodu	Product Code	048 095 000400
Ölçü	Dimension	120x120x20,5 mm
Kesim Ölçüsü	Diameter	92x92 mm
Koruma Sınıfı	Protect Class	IP54
Adet	Quantity	1



Ürün Kodu	Product Code	048 095 000401
Ölçü	Dimension	160x160x31 mm
Kesim Ölçüsü	Diameter	125x125 mm
Koruma Sınıfı	Protect Class	IP54
Adet	Quantity	1



Ürün Kodu	Product Code	048 095 000402
Ölçü	Dimension	210x210x31 mm
Kesim Ölçüsü	Diameter	177x177 mm
Koruma Sınıfı	Protect Class	IP54
Adet	Quantity	1



Ürün Kodu	Product Code	048 095 000403
Ölçü	Dimension	260x260x31 mm
Kesim Ölçüsü	Diameter	223x223 mm
Koruma Sınıfı	Protect Class	IP54
Adet	Quantity	1



Ürün Kodu	Product Code	048 095 000404
Ölçü	Dimension	325x325x31 mm
Kesim Ölçüsü	Diameter	291x291 mm
Koruma Sınıfı	Protect Class	IP54
Adet	Quantity	1



PROJE CEPLERİ PROJECT SIZE		
Ürün Kodu	Product Code	A4 / 048 095 000902
Ürün Kodu	Product Code	A5 / 048 095 000903
Ölçü	Dimension	A4 / A5
Adet	Quantity	1

YENİ
NEW



UV DAYANIMLI POLYAMID SPIRALLER

UV RESISTANT POLYAMIDE SPIRALS



@mutlusanelectric



@mutlusanelk



@mutlusanelektrik



@mutlusanplastikelektrik



HER BAĞLANTIDA KALİTE

QUALITY IN EVERY CONNECTION

UV DAYANIMLI POLYAMİD SPİRALLER

POLYAMID SPIRALS

ISO 4892-2 UV ve yaşlandırma testlerinden başarı ile onaylı,
Yüksek ultraviyole dayanımına sahip,
Halojen free spiral alev yaymayan
Kükürt ve fosfor içermez,
Düşük duman, düşük toksisite özellikli,
-40° ile +120° arasında çalışmaya uygun,

Successfully certified with ISO 4892-2 UV and aging tests,
High ultraviolet resistance,
Halogen-free spiral, non-flame spreading,
Contains no sulfur or phosphorus,
Low smoke, low toxicity,
Suitable for operation between -40° and +120°.



SUNFLEX POLYAMİD SPİRAL BORU UV DAYANIMLI

SUNFLEX POLYAMIDE SPIRAL PIPE UV RESISTANT

KOD CODE	RAKOR ÖLÇÜ CABLE GLAND DIMENSION	İÇ ÇAP INNER DIAMETER	DIŞ ÇAP OUTER DIAMETER	KUTU BOX	KOLİ PARCEL	KUTU AĞIRLIK BOX WEIGHT kg	KUTU HACİM BOX VOLUME m3
001 020 180007 00 XX	PSR7	7,00 mm	10,10 mm	100 mt	1000 mt	1,9	0,02
001 020 180009 00 XX		8,40 mm	12,05 mm	100 mt	1000 mt	2,3	0,0268
001 020 180010 00 XX	PSR9	10,20 mm	13,10 mm	100 mt	1000 mt	2,8	0,02573
001 020 180012 00 XX	PSR11	12,30 mm	15,90 mm	50 mt	500 mt	1,85	0,02
001 020 180014 00 XX	PSR13,5	14,10 mm	18,35 mm	50 mt	250 mt	2,15	0,05755
001 020 180017 00 XX	PSR16	17,00 mm	21,45 mm	50 mt	250 mt	2,9	0,03872
001 020 180019 00 XX		19,00 mm	24,25 mm	50 mt	250 mt	3,15	0,04608
001 020 180023 00 XX	PSR21	23,25 mm	28,50 mm	50 mt	250 mt	4,2	0,063525
001 020 180026 00 XX		26,20 mm	31,30 mm	25 mt	125 mt	2,4	0,0405
001 020 180029 00 XX	PSR29	29,10 mm	34,30 mm	25 mt	125 mt	2,65	0,05
001 020 180036 00 XX	PSR36	36,20 mm	42,20 mm	25 mt	125 mt	3,15	0,070645
001 020 180048 00 XX	PSR48	48,50 mm	54,50 mm	25 mt	125 mt	4,7	0,1078

x: SİYAH/BLACK 1 - GRİ/GRAY 3



ALEV YAYMAYAN
PA6 POLYAMİD SİRAL
NON-FLAME PA6 POLYAMIDE SPIRAL

KOD CODE	ÜRÜN TANIMI DESCRIPTION	RAKOR ÖLÇÜ CABLE GLAND DIMENSION	İÇ ÇAP INNER DIAMETER	DIŞ ÇAP OUTER DIAMETER	KUTU BOX	KOLİ PARCEL	KUTU AĞIRLIK BOX WEIGHT kg	KUTU HACİM BOX VOLUME m ³
001 020 170007 00 XX	MUT/PA6-7	PSR7	7,00 mm	10,10 mm	100 mt	1000 mt	1,94	0,018
001 020 170009 00 XX	MUT/PA6-8,5		8,40 mm	12,05 mm	100 mt	1000 mt	2,34	0,0268
001 020 170010 00 XX	MUT/PA6-10	PSR9	10,20 mm	13,10 mm	100 mt	1000 mt	2,84	0,02573
001 020 170012 00 XX	MUT/PA6-12	PSR11	12,30 mm	15,90 mm	50 mt	500 mt	1,85	0,0218
001 020 170014 00 XX	MUT/PA6-14	PSR13,5	14,10 mm	18,35 mm	50 mt	250 mt	2,15	0,05755
001 020 170017 00 XX	MUT/PA6-17	PSR16	17,00 mm	21,45 mm	50 mt	250 mt	2,91	0,03872
001 020 170019 00 XX	MUT/PA6-19		19,00 mm	24,25 mm	50 mt	250 mt	3,15	0,04608
001 020 170023 00 XX	MUT/PA6-23	PSR21	23,25 mm	28,50 mm	50 mt	250 mt	4,2	0,063525
001 020 170026 00 XX	MUT/PA6-26		26,20 mm	31,30 mm	25 mt	125 mt	2,4	0,0405
001 020 170029 00 XX	MUT/PA6-29	PSR29	29,10 mm	34,30 mm	25 mt	125 mt	2,661	0,05
001 020 170036 00 XX	MUT/PA6-36	PSR36	36,20 mm	42,20 mm	25 mt	125 mt	3,161	0,070645
001 020 170048 00 XX	MUT/PA6-48	PSR48	48,50 mm	54,50 mm	25 mt	125 mt	4,694	0,1078

x: SİYAH/BLACK 1 - GRİ/GRAY 3



ALEV YAYMAYAN
POLYAMİD YARIKLI SİRAL BORU
NON-FLAME POLYAMIDE SPLITTED SPIRAL PIPE

KOD CODE	ÜRÜN TANIMI DESCRIPTION	İÇ ÇAP INNER DIAMETER	DIŞ ÇAP OUTER DIAMETER	KUTU BOX	KOLİ PARCEL	KUTU AĞIRLIK BOX WEIGHT kg	KUTU HACİM BOX VOLUME m ³
001 020 470007 00 XX	PSR7	7,00 mm	10,10 mm	100 mt	1000 mt	1,9	0,02
001 020 470009 00 XX		8,40 mm	12,05 mm	100 mt	1000 mt	2,3	0,0268
001 020 470010 00 XX	PSR9	10,20 mm	13,10 mm	100 mt	1000 mt	2,8	0,02573
001 020 470012 00 XX	PSR11	12,30 mm	15,90 mm	50 mt	500 mt	1,85	0,0218
001 020 470014 00 XX	PSR13,5	14,10 mm	18,35 mm	50 mt	250 mt	2,15	0,05755
001 020 470017 00 XX	PSR16	17,00 mm	21,45 mm	50 mt	250 mt	2,9	0,03872
001 020 470019 00 XX		19,00 mm	24,25 mm	50 mt	250 mt	3,15	0,04608
001 020 470023 00 XX	PSR21	23,25 mm	28,50 mm	50 mt	250 mt	4,2	0,063525
001 020 470026 00 XX		26,20 mm	31,30 mm	25 mt	125 mt	2,4	0,0405
001 020 470029 00 XX	PSR29	29,10 mm	34,30 mm	25 mt	125 mt	2,65	0,05
001 020 470036 00 XX	PSR36	36,20 mm	42,20 mm	25 mt	125 mt	3,15	0,070645
001 020 470048 00 XX	PSR48	48,50 mm	54,50 mm	25 mt	125 mt	4,7	0,1078

x: SİYAH/BLACK 1 - GRİ/GRAY 3

POLYAMİD SİRİAL RAKOR

POLYAMİD SPIRALS

YENİ
NEW



POLYAMİD SİRİAL RAKORU (GRİ/SİYAH)

POLYEMIDE SPIRAL CABLE GLANDS (GRAY/BLACK)

KOD CODE	ÜRÜN TANIMI DESCRIPTION	İÇ ÇAP INNER DIAMETER	DIŞ ÇAP OUTER DIAMETER	KUTU BOX	KOLİ PARCEL	KUTU AĞIRLIK BOX WEIGHT kg	KUTU HACİM BOX VOLUME m ³
057 097 1X0007	PSR-7	7,00 mm	10,10 mm	50	5000	0,23	0,00068112
057 097 1X0009	PSR-9	8,40 mm	12,05 mm	50	3000	0,325	0,0011352
057 097 1X0011	PSR-11	10,20 mm	13,10 mm	50	2000	0,4375	0,0017028
057 097 1X0135	PSR-13,5	12,30 mm	15,90 mm	50	1700	0,588235294	0,002003294
057 097 1X0016	PSR-16	14,10 mm	18,35 mm	50	1200	0,6875	0,002838
057 097 1X0021	PSR-21	17,00 mm	21,45 mm	25	800	0,5	0,0021285
057 097 1X0029	PSR-29	19,00 mm	24,25 mm	20	500	0,56	0,00272448
057 097 1X0036	PSR-36	23,25 mm	28,50 mm	10	300	0,633333333	0,0022704
057 097 1X0048	PSR-48	26,20 mm	31,30 mm	10	200	0,625	0,0034056

x: SİYAH/BLACK 1 - GRİ/GRAY 3

METRİK POLYAMİD SİRİAL RAKORU

PLUG - SOCKET GROUP (THREE PHASE)

KOD CODE	ÜRÜN TANIMI DESCRIPTION	İÇ ÇAP INNER DIAMETER	DIŞ ÇAP OUTER DIAMETER	KUTU BOX	KOLİ PARCEL	KUTU AĞIRLIK BOX WEIGHT kg	KUTU HACİM BOX VOLUME m ³
057 097 111012	M12X1.5 (PSR-7)	7,00 mm	10,10 mm	50	3000	0,233333333	0,0011352
057 097 111016	M16X1.5 (PSR-9)	8,40 mm	12,05 mm	50	3000	0,325	0,0011352
057 097 111018	M18X1.5 (PSR-11)	10,20 mm	13,10 mm	50	2000	0,4375	0,0017028
057 097 111020	M20X1.5 (PSR-13,5)	12,30 mm	15,90 mm	50	1700	0,588235294	0,002003294
057 097 111025	M25X1.5 (PSR-16)	14,10 mm	18,35 mm	50	1200	0,6875	0,002838
057 097 111125	M25X1.5 (PSR-21)	17,00 mm	21,45 mm	50	800	1	0,004257
057 097 111032	M32X1.5 (PSR-29)	19,00 mm	24,25 mm	50	500	1,4	0,0068112
057 097 111040	M40X1.5 (PSR-36)	23,25 mm	28,50 mm	50	2100	3,1	0,011352
057 097 111050	M50X1.5 (PSR-48)	26,20 mm	31,30 mm	50	200	3,125	0,017028

POLYAMİD SİRİAL DİRSEĞİ (GRİ/SİYAH)

POLYAMİDE SPIRAL (GRAY/BLACK)

KOD CODE	ÜRÜN ADI PRODUCT NAME	KABLO ÇAP CABLE DIAMETER	KUTU BOX	KOLİ PARCEL	KUTU AĞIRLIK BOX WEIGHT kg	KUTU HACİM BOX VOLUME m ³
057 097 12X007	PSRD-7 / 90° DİRSEK BRACKETS	3-6,5 mm	50	3200	0,35	0,0010545
057 097 12X009	PSRD-9 / 90° DİRSEK BRACKETS	4-6 mm	50	2400	0,45	0,001406
057 097 12X011	PSRD-11 / 90° DİRSEK BRACKETS	5-10 mm	50	1600	0,55	0,002109
057 097 12X135	PSRD-13,5 / 90° DİRSEK BRACKETS	6-12 mm	50	1200	0,8	0,002812
057 097 12X016	PSRD-16 / 90° DİRSEK BRACKETS	10-14 mm	50	900	0,95	0,003749
057 097 12X021	PSRD-21 / 90° DİRSEK BRACKETS	13-18 mm	25	700	0,5	0,002410303



x: SİYAH/BLACK 1 - GRİ/GRAY 3

POLYAMİD SİRİAL KROŞELERİ (GRİ/SİYAH)

POLYAMİDE SPIRAL CABLE STRAPS (GRAY/BLACK)

KOD CODE	ÜRÜN ADI PRODUCT NAME	KABLO ÇAP CABLE DIAMETER	KUTU BOX	KOLİ PARCEL	KUTU AĞIRLIK BOX WEIGHT kg	KUTU HACİM BOX VOLUME m ³
057 097 16X007	PG-7	-	50	6000	0,15	0,000562
057 097 16X009	PG-9	-	50	4400	0,2	0,0007665
057 097 16X011	PG-11	-	50	2700	0,25	0,0012495
057 097 16X135	PG-13,5	-	50	3000	0,25	0,0011245
057 097 16X016	PG-16	-	50	2600	0,25	0,0012975
057 097 16X021	PG-21	-	25	1400	0,225	0,001205
057 097 16X029	PG-29	-	25	1000	0,275	0,001687
057 097 16X036	PG-36	-	25	550	0,55	0,00305
057 097 16X048	PG-48	-	10	320	0,37	0,002109



CE

YENİ
NEW



R-MEKS

R-MEKS PG PLASTİK KABLO RAKORU
PLUG - SOCKET GROUP (THREE PHASE)



KOD CODE	ÜRÜN ADI PRODUCT NAME	KABLO ÇAPI CABLE DIAMETER	KUTU BOX	AĞIRLIK WEIGHT kg	HACİM VOLUME m3
010 097 1X0007	R-MEKS PG-7	3-6,5 mm	3-6,5 mm	2,7	0,0077265
010 097 1X0009	R-MEKS PG-9	4-6 mm	4-6 mm	2,1	0,007728
010 097 1X0011	R-MEKS PG-11	5-10 mm	5-10 mm	2	0,007728
010 097 1X0135	R-MEKS PG-13,5	6-12 mm	6-12 mm	2,1	0,007728
010 097 1X0016	R-MEKS PG-16	10-14 mm	10-14 mm	2	0,0077275
010 097 1X0021	R-MEKS PG-21	13-18 mm	13-18 mm	1,725	0,007728
010 097 1X0029	R-MEKS PG-29	18-25 mm	18-25 mm	1,68	0,007728
010 097 1X0036	R-MEKS PG-36	22-32 mm	22-32 mm	1,6	0,007728
010 097 1X0042	R-MEKS PG-42	32-38 mm	32-38 mm	1,395	0,007728
010 097 1X0048	R-MEKS PG-48	37-44 mm	37-44 mm	1,356	0,007728

R-MEKS METRİK PLASTİK KABLO RAKORU
PLUG - SOCKET GROUP (THREE PHASE)



KOD CODE	ÜRÜN ADI PRODUCT NAME	KABLO ÇAPI CABLE DIAMETER	KUTU BOX	AĞIRLIK WEIGHT kg	HACİM VOLUME m3
010 097 1X0712	R-MEKS M12X1,5 PG-7	3-6,5 mm	450	2,7	0,0077265
010 097 1X1112	R-MEKS M16X1,5 PG-11	5-10 mm	200	2	0,007728
010 097 1X1320	R-MEKS M20X1,5 PG-13,5	6-12 mm	175	2,1	0,007728
010 097 1X1620	R-MEKS M20X1,5 PG-16	10-14 mm	125	2	0,0077275
010 097 1X2125	R-MEKS M25X1,5 PG-21	13-18 mm	75	1,725	0,007728
010 097 1X2932	R-MEKS M32X1,5 PG-29	18-25 mm	40	1,68	0,007728
010 097 1X3640	R-MEKS M40X1,5 PG-36	22-32 mm	20	1,6	0,007728
010 097 1X4250	R-MEKS M50X1,5 PG-42	32-38 mm	15	1,395	0,007728
010 097 1X4863	R-MEKS M63X1,5 PG-48	37-44 mm	12	1,356	0,007728

X: GRİ/GRAY 7
X: SİYAH/BLACK 1

YENİ
NEW

R-MEKS

"Yenilikle Dayanıklılığı Bağlayın."

"Connecting Innovation with Durability."



PG

METRİK

YENİ
NEW

Promex

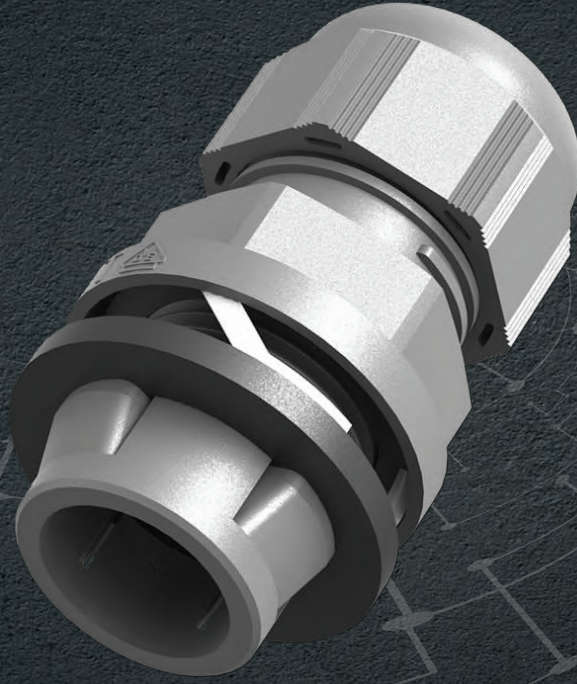

Kolay ve Hızlı Montaj

Easy and

Quick Assembly

PROMEX KABLO RAKORU

PROMEX CABLE GLAND

YENİ
NEW

Promex

PROMEX SMART PLASTİK KABLO RAKORU

PROMEX SMART PLASTIC CABLE GLAND



KOD CODE	AÇIKLAMA EXPLANATION	KABLO SIKMA CABLE DIAMETER Ø	DELİK ÇAPI HOLE DIAMETER Ø	KUTU BOX	KOLİ PARCEL	KUTU AĞIRLIK BOX WEIGHT kg	KUTU HACİM BOX VOLUME m ³
057 097 411X16	16'lik SMART	5-10 mm	16 mm	150	1500	2,1	0,008027595
057 097 412X20	20'lik SMART	6-12 mm	20 mm	120	1200	1,92	0,008027712
057 097 422X25	25'lik SMART	11-17 mm	25 mm	50	500	1,1	0,0080276
057 097 422X32	32'lik SMART	15-21 mm	32 mm	40	400	1,24	0,0080276
057 097 422X40	40'lik SMART	19-28 mm	40 mm	20	200	1,02	0,0080276

x: AÇIK GRİ/LIGHT GRAY 0 - SİYAH/BLACK 1 - GRİ/GRAY 3



PROMEX PG PLASTİK KABLO RAKORU

PROMEX PG PLASTIC CABLE GLAND



KOD CODE	AÇIKLAMA EXPLANATION	KABLO SIKMA CABLE DIAMETER Ø	DELİK ÇAPI HOLE DIAMETER Ø	KUTU BOX	KOLİ PARCEL	KUTU AĞIRLIK BOX WEIGHT kg	KUTU HACİM BOX VOLUME m ³
057 097 211X07	PG 7	3-6,5mm	13	450	4500	2,25	0,0080276
057 097 212X09	PG 9	4-8mm	15,5	300	3000	2,4	0,00802761
057 097 213X11	PG 11	5-10mm	19	200	2000	2	0,0080276
057 097 214X14	PG 13,5	6-12mm	20,5	175	1750	2,275	0,0080276
057 097 215X16	PG 16	10-14mm	22,5	125	1250	2,125	0,0080276
057 097 216X21	PG 21	13-18mm	28,5	75	750	2,025	0,008027625
057 097 217X29	PG 29	18-25mm	37,5	40	400	1,8	0,0080276
057 097 218X36	PG 36	22-32mm	57,5	20	200	1,7	0,0080276
057 097 219X42	PG 42	30-38mm	54,5	15	150	1,245	0,00797595
057 097 220X48	PG 48	34-44mm	60,5	12	120	1,116	0,008027604

x: AÇIK GRİ/LIGHT GRAY 0 - SİYAH/BLACK 1 - GRİ/GRAY 3



PROMEX METRİK PLASTİK KABLO RAKORU

PROMEX METRIC PLASTIC CABLE GLAND



KOD CODE	AÇIKLAMA EXPLANATION	KABLO SIKMA CABLE DIAMETER Ø	DELİK ÇAPI HOLE DIAMETER Ø	KUTU BOX	KOLİ PARCEL	KUTU AĞIRLIK BOX WEIGHT kg	KUTU HACİM BOX VOLUME m ³
057 097 310X12	M12X1,5	3-6,5mm	12mm	450	4500	2,25	0,008027595
057 097 311X16	M16X1,5	5-10mm	16mm	200	2000	2,2	0,0080276
057 097 312X20	M20X1,5	6-12mm	20mm	175	1750	2,45	0,0080276
057 097 313X20	M20X1,5	10-14mm	20mm	125	1250	2	0,0080276
057 097 314X20	M20X1,5	10-14mm	20mm	125	1250	2,125	0,0080276
057 097 315X25	M25X1,5	13-18mm	25mm	75	750	2,025	0,008027625
057 097 316X25	M25X1,5	13-18mm	25mm	75	750	2,1	0,008027625
057 097 317X32	M32X1,5	18-25mm	32mm	40	400	1,92	0,0080276
057 097 318X40	M40X1,5	22-32mm	40mm	20	200	1,72	0,0080276
057 097 319X50	M50X1,5	30-38mm	50mm	15	150	1,575	0,008027595
057 097 320X63	M63X1,5	34-44mm	63mm	12	120	1,344	0,008024364

x: AÇIK GRİ/LIGHT GRAY 0 - SİYAH/BLACK 1 - GRİ/GRAY 3



PROMEX METRİK PLASTİK KABLO RAKORU

PROMEX METRIC PLASTIC CABLE GLAND

KOD CODE	AÇIKLAMA EXPLANATION	KABLO SIKMA CABLE DIAMETER Ø	DİŞ BOYU TOOTH LENGTH	KUTU BOX	KOLİ PARCEL	KUTU AĞIRLIK BOX WEIGHT kg	KUTU HACİM BOX VOLUME m ³
057 097 601007	PG-7	3,00-6,50 mm	8 mm	100	2500	-	-
057 097 602009	PG-9	4,00-8,00 mm	8 mm	50	1500	-	-
057 097 603011	PG-11	5,00-10,00 mm	8 mm	50	1500	-	-
057 097 604014	PG-13,5	6,00-12,00 mm	10 mm	50	1000	-	-
057 097 605016	PG-16	10,00-14,00 mm	10 mm	50	500	-	-
057 097 606021	PG-21	13,00-18,00 mm	11 mm	25	250	-	-



PROMEX HAVALANDIRMA TAPASI PLASTİK
PLUG - SOCKET GROUP (THREE PHASE)



KOD CODE	ÜRÜN TANIMI DESCRIPTION	İÇ ÇAP INNER DIAMETER	KUTU BOX	KOLİ PARCEL	KUTU AĞIRLIK BOX WEIGHT	KUTU HACİM BOX VOLUME
057 097 701006	M6X0,75	7,00 mm	100	10000	100 mt	100 mt
057 097 702008	M8X1,0	8,40 mm	100	5000	100 mt	100 mt
057 097 703012	M12X1,5	10,20 mm	100	3000	100 mt	100 mt
057 097 704016	M16X1,5	12,30 mm	100	1000	50 mt	50 mt
057 097 705020	M20X1,5	14,10 mm	100	1000	50 mt	50 mt
057 097 706040	M40X1,5	17,00 mm	50	200	50 mt	50 mt

PROMEX METAL RAKOR
PROMEX METAL CABLE GLAND



KOD CODE	ÜRÜN TANIMI DESCRIPTION	KABLO SIKMA ÇAPI CABLE TIGHTENING DIAMETER	DİŞ BOYU TOOTH LENGTH	KUTU BOX	KOLİ PARCEL	KUTU AĞIRLIK BOX WEIGHT kg	KUTU HACİM BOX VOLUME m ³
057 097 101007	PG-7	3,00-6,5mm	6mm	50	1000	-	-
057 097 102009	PG-9	4,00-8,00mm	6mm	50	900	-	-
057 097 103011	PG-11	5,00-10,00mm	6mm	50	600	-	-
057 097 104014	PG-13,5	6,00-12,00mm	6,5mm	50	500	-	-
057 097 105016	PG-16	10,00-14,00mm	6,5mm	50	400	-	-
057 097 106021	PG-21	13,00-18,00mm	7,2mm	25	200	-	-
057 097 107029	PG-29	18,00-25,00mm	8mm	10	100	-	-
057 097 108036	PG-36	22,00-32,00mm	9mm	5	50	-	-
057 097 109042	PG-42	30,00-38,00mm	12mm	5	40	-	-
057 097 11048	PG-48	34,00-44,00mm	24mm	5	40	-	-
057 097 101107	M12X1.5 PG-7	3,00-6,50mm	6mm	50	1000	-	-
057 097 101109	M16X1.5 PG-9	4,00-8,00mm	7mm	50	900	-	-
057 097 101114	M20X1.5 PG-13.5	6,00-12,00mm	8mm	50	500	-	-
057 097 101116	M25X1.5 PG-16	13,00-18,00mm	8mm	25	350	-	-
057 097 101121	M32X1.5 PG-21	18,00-25,00mm	9mm	10	200	-	-
057 097 101129	M40X1.5 PG-29	22,00-32,00mm	9mm	10	100	-	-
057 097 101136	M50X1.5 PG-36	34,00-44,00mm	9mm	5	50	-	-
057 097 101148	M63X1.5 PG-48	34,00-44,00mm	14mm	5	40	-	-

PROMEX PLASTİK/METAL HAVALANDIRMA RAKORU
PLUG - SOCKET GROUP (THREE PHASE)



KOD CODE	ÜRÜN TANIMI DESCRIPTION	KABLO SIKMA ÇAPI CABLE TIGHTENING DIAMETER	DİŞ BOYU TOOTH LENGTH	KUTU BOX	KOLİ PARCEL	KUTU AĞIRLIK BOX WEIGHT kg	KUTU HACİM BOX VOLUME m ³
057 097 801012	M12X1.5	4,00-7,00mm	8mm	100	2000	-	-
057 097 801016	M16X1.5	4,00-7,00mm	10mm	50	2000	-	-
057 097 801020	M20X1.5	6,00-11,00mm	10mm	50	1500	-	-
057 097 802009	PG-9	4,00-7,00mm	8mm	50	2000	-	-
057 097 802011	PG-11	4,00-7,00mm	8mm	50	2000	-	-
057 097 802014	PG-13,5	6,00-11,00mm	8mm	50	1500	-	-
057 097 803012	M12X1,5	2,00-6,00mm	9mm	50	1000	-	-
057 097 803016	M16X1,5	4,00-7,00mm	8mm	50	900	-	-
057 097 803020	M20X1,5	6,00-11,00mm	8mm	50	500	-	-
057 097 804007	PG-7	2,00-6,00mm	8mm	50	1000	-	-
057 097 804009	PG-9	4,00-7,00mm	8mm	50	900	-	-
057 097 804011	PG-11	5,00-9,00mm	8mm	50	600	-	-
057 097 804014	PG-13,5	6,00-11,00mm	9mm	50	500	-	-

KABLO BAĞLARI CABLESTRAPS

YENİ
NEW



ULTRAVİYOLE KABLO BAĞI (SİYAH) MUTLUSAN CABLESTRAPS WITH CONCRETE NAIL(BLACK)

KOD CODE	AÇIKLAMA DESCRIPTION	AMBALAJ PACKING	ADET PACKING	AĞIRLIK WEIGHT	HACİM VOLUME	
062 129 225100	UV KABLO BAĞI SİYAH UV CABLE TIE BLACK	2,5x100	KUTU PACK	30000	26,7 kg	0,060
062 129 225140	UV KABLO BAĞI SİYAH UV CABLE TIE BLACK	2,5x140	KUTU PACK	30000	26,7 kg	0,060
062 129 225200	UV KABLO BAĞI SİYAH UV CABLE TIE BLACK	2,5x200	KUTU PACK	30000	26,7 kg	0,060
062 129 236150	UV KABLO BAĞI SİYAH UV CABLE TIE BLACK	3,6x150	KUTU PACK	30000	26,7 kg	0,060
062 129 236205	UV KABLO BAĞI SİYAH UV CABLE TIE BLACK	3,6x205	KUTU PACK	30000	26,7 kg	0,060
062 129 236250	UV KABLO BAĞI SİYAH UV CABLE TIE BLACK	3,6x250	KUTU PACK	30000	26,7 kg	0,060
062 129 236300	UV KABLO BAĞI SİYAH UV CABLE TIE BLACK	3,6x300	KUTU PACK	30000	26,7 kg	0,060
062 129 236370	UV KABLO BAĞI SİYAH UV CABLE TIE BLACK	3,6x370	KUTU PACK	30000	26,7 kg	0,060
062 129 248200	UV KABLO BAĞI SİYAH UV CABLE TIE BLACK	4,8x200	KUTU PACK	30000	26,7 kg	0,060
062 129 248250	UV KABLO BAĞI SİYAH UV CABLE TIE BLACK	4,8x250	KUTU PACK	30000	26,7 kg	0,060
062 129 248300	UV KABLO BAĞI SİYAH UV CABLE TIE BLACK	4,8x300	KUTU PACK	30000	26,7 kg	0,060
062 129 248350	UV KABLO BAĞI SİYAH UV CABLE TIE BLACK	4,8x350	KUTU PACK	30000	26,7 kg	0,060
062 129 248400	UV KABLO BAĞI SİYAH UV CABLE TIE BLACK	4,8x400	KUTU PACK	30000	26,7 kg	0,060
062 129 248450	UV KABLO BAĞI SİYAH UV CABLE TIE BLACK	4,8x450	KUTU PACK	30000	26,7 kg	0,060
062 129 208250	UV KABLO BAĞI SİYAH UV CABLE TIE BLACK	8x250	KUTU PACK	30000	26,7 kg	0,060
062 129 208300	UV KABLO BAĞI SİYAH UV CABLE TIE BLACK	8x300	KUTU PACK	30000	26,7 kg	0,060
062 129 208380	UV KABLO BAĞI SİYAH UV CABLE TIE BLACK	8x380	KUTU PACK	30000	26,7 kg	0,060
062 129 208450	UV KABLO BAĞI SİYAH UV CABLE TIE BLACK	8x450	KUTU PACK	30000	26,7 kg	0,060
062 129 208550	UV KABLO BAĞI SİYAH UV CABLE TIE BLACK	8x550	KUTU PACK	30000	26,7 kg	0,060
062 129 208750	UV KABLO BAĞI SİYAH UV CABLE TIE BLACK	8x750	KUTU PACK	30000	26,7 kg	0,060
062 129 209762	UV KABLO BAĞI SİYAH UV CABLE TIE BLACK	9x762	KUTU PACK	30000	26,7 kg	0,060
062 129 209940	UV KABLO BAĞI SİYAH UV CABLE TIE BLACK	9x940	KUTU PACK	30000	26,7 kg	0,060



MUTLUSAN KABLO BAĞI MUTLUSAN CABLE TIES

KOD/BEYAZ CODE/WHITE	KOD/SİYAH CODE/BLACK	AÇIKLAMA DESCRIPTION	AMBALAJ PACKING	ADET PACKING	AĞIRLIK WEIGHT	HACİM VOLUME	
062 129 025100	062 129 225100	KABLO BAĞI CABLE TIE	2,5x100	KUTU PACK	30000	26,7 kg	0,060
062 129 025140	062 129 225100	KABLO BAĞI CABLE TIE	2,5x140	KUTU PACK	30000	26,7 kg	0,060
062 129 025200	062 129 225100	KABLO BAĞI CABLE TIE	2,5x200	KUTU PACK	30000	26,7 kg	0,060
062 129 036150	062 129 225100	KABLO BAĞI CABLE TIE	3,6x150	KUTU PACK	30000	26,7 kg	0,060
062 129 036205	062 129 225100	KABLO BAĞI CABLE TIE	3,6x205	KUTU PACK	30000	26,7 kg	0,060
062 129 036250	062 129 225100	KABLO BAĞI CABLE TIE	3,6x250	KUTU PACK	30000	26,7 kg	0,060
062 129 036300	062 129 225100	KABLO BAĞI CABLE TIE	3,6x300	KUTU PACK	30000	26,7 kg	0,060
062 129 036370	062 129 225100	KABLO BAĞI CABLE TIE	3,6x370	KUTU PACK	30000	26,7 kg	0,060
062 129 048200	062 129 225100	KABLO BAĞI CABLE TIE	4,8x200	KUTU PACK	30000	26,7 kg	0,060
062 129 048250	062 129 225100	KABLO BAĞI CABLE TIE	4,8x250	KUTU PACK	30000	26,7 kg	0,060
062 129 048300	062 129 225100	KABLO BAĞI CABLE TIE	4,8x300	KUTU PACK	30000	26,7 kg	0,060
062 129 048350	062 129 225100	KABLO BAĞI CABLE TIE	4,8x350	KUTU PACK	30000	26,7 kg	0,060
062 129 048400	062 129 225100	KABLO BAĞI CABLE TIE	4,8x400	KUTU PACK	30000	26,7 kg	0,060
062 129 048450	062 129 225100	KABLO BAĞI CABLE TIE	4,8x450	KUTU PACK	30000	26,7 kg	0,060
062 129 008250	062 129 225100	KABLO BAĞI CABLE TIE	8x250	KUTU PACK	30000	26,7 kg	0,060
062 129 008300	062 129 225100	KABLO BAĞI CABLE TIE	8x300	KUTU PACK	30000	26,7 kg	0,060
062 129 008380	062 129 225100	KABLO BAĞI CABLE TIE	8x380	KUTU PACK	30000	26,7 kg	0,060
062 129 008450	062 129 225100	KABLO BAĞI CABLE TIE	8x450	KUTU PACK	30000	26,7 kg	0,060
062 129 008550	062 129 225100	KABLO BAĞI CABLE TIE	8x550	KUTU PACK	30000	26,7 kg	0,060
062 129 008750	062 129 225100	KABLO BAĞI CABLE TIE	8x750	KUTU PACK	30000	26,7 kg	0,060
062 129 009762	062 129 225100	KABLO BAĞI CABLE TIE	9x762	KUTU PACK	30000	26,7 kg	0,060
062 129 009940	062 129 225100	KABLO BAĞI CABLE TIE	9x940	KUTU PACK	30000	26,7 kg	0,060

KROŞELER VE KLİPSLER

CABLE STRAPS AND CLIPSES



KROŞE VE KLİPSLER

CROCHET AND CLIPS

KOD CODE	AÇIKLAMA DESCRIPTION	AMBALAJ PACKING	KUTU BOX	KOLİ PARCEL
062 129 132020	20x20 YAPIŞKAN KROŞE / 20x20 ADHESIVE CROCHET	KUTU / PACK	100	20.000
062 129 132828	28x28 YAPIŞKAN KROŞE / 28x28 ADHESIVE CROCHETS	KUTU / PACK	100	9.000
062 129 131316	13x16 YAPIŞKAN KLİPS / 13x16 ADHESIVE CLIP	KUTU / PACK	100	7.000
062 129 191325	13x25 YAPIŞKAN KLİPS / 13x25 ADHESIVE CLIP	KUTU / PACK	100	5.000
062 129 132525	25x25 YAPIŞKAN KLİPS (BEYAZ) / 25x25 ADHESIVE CLIP (WHITE)	KUTU / PACK	100	3.000
062 129 142525	25x25 YAPIŞKAN KLİPS (SİYAH) / 25x25 ADHESIVE CLIP (BLACK)	KUTU / PACK	100	2.000
062 129 151017	10x17 VİDALI KROŞE / 10x17 CROCHET WITH SCREW	KUTU / PACK	250	12.500
062 129 151530	15x30 VİDALI KROŞE / 15x30 CROCHET WITH SCREW	KUTU / PACK	100	5.000
062 129 151723	17x23 VİDALI KROŞE / 17x23 CROCHET WITH SCREW	KUTU / PACK	250	5.000
062 129 161004	DÜBELLİ KROŞE 6 DELİK İÇİN / CROCHET WITH DOWEL 6 HOLES	KUTU / PACK	500	15.000
062 129 171009	DUVAR KROŞESİ 6 DELİK İÇİN / WALL CROCHET 6 HOLES	KUTU / PACK	250	7.500
062 129 100008	DUVAR KROŞESİ 8 DELİK İÇİN / WALL CROCHET 8 HOLES	KUTU / PACK	250	9.000
062 129 171011	KANAL KROŞESİ 6 DELİK İÇİN / TRUNKING CROCHET 6 HOLES	KUTU / PACK	250	7.500
062 129 500003	KABLO KLİPSİ 6,4 (1/4") / CABLE CLIP 6,4 (1/4")	KUTU / PACK	100	10.000
062 129 500004	KABLO KLİPSİ 7,9 (5/6") / CABLE CLIP 7,9 (5/6")	KUTU / PACK	100	5.000
062 129 500005	KABLO KLİPSİ 10,9 (3/8") / CABLE CLIP 10,9 (3/8")	KUTU / PACK	100	5.000



KELEPÇELER

CLAMPS

KOD CODE	AÇIKLAMA DESCRIPTION	ÖLÇÜ DIMENSIONS	AMBALAJ PACKING	KUTU BOX	KOLİ PARCEL
062 129 010101	BONCUK KELEPÇE / 2x105 PLASTIC CLIPS	2x105	KUTU / PACK	1000	25.000
062 129 010102	BONCUK KELEPÇE / 3,5x165 PLASTIC CLIPS	3,5x165	KUTU / PACK	500	8.000
062 129 500000	BONCUK KELEPÇE / 3,5x235 PLASTIC CLIPS	3,5x235	KUTU / PACK	100	5.000
062 120 005105	BURMA KELEPÇE / 4,5mm TWIST CLAMP	4,5mm	KUTU / PACK	500	50.000
062 120 007107	BURMA KELEPÇE / 7,0mm TWIST CLAMP	7,0mm	KUTU / PACK	500	45.000
062 120 010110	BURMA KELEPÇE / 10,5mm TWIST CLAMP	10,5mm	KUTU / PACK	500	35.000
062 120 014114	BURMA KELEPÇE / 14mm TWIST CLAMP	14mm	KUTU / PACK	500	30.000
062 120 017117	BURMA KELEPÇE / 17mm TWIST CLAMP	17mm	KUTU / PACK	500	15.000



ETİKETLER

LABELS

KOD CODE	AÇIKLAMA DESCRIPTION	ÖLÇÜ DIMENSIONS	AMBALAJ PACKING	KUTU ADET BOX QUANTITY	KOLİ ADET CASE QUANTITY
062 129 111035	KABLO BAĞI ETİKETİ /CABLE TIE LABEL	10x35	KUTU / PACK	100	4000
062 129 112045	KABLO BAĞI ETİKETİ /CABLE TIE LABEL	20x45	KUTU / PACK	100	1500
062 129 121730	YAPIŞKANLI PANO ETİKETİ /ADHESIVE PANEL LABEL	17x30	KUTU / PACK	100	5000
062 129 121750	YAPIŞKANLI PANO ETİKETİ /ADHESIVE PANEL LABEL	17x50	KUTU / PACK	50	2000
062 129 122075	YAPIŞKANLI PANO ETİKETİ /ADHESIVE PANEL LABEL	17x75	KUTU / PACK	25	1500



HELEZON PANO SİRALI

HELICAL PANEL SPIRAL

KOD CODE	AÇIKLAMA DESCRIPTION	İÇ ÇAP INNER DIAMETER	DIŞ ÇAP OUTER DIAMETER	KUTU ADET BOX QUANTITY	KOLİ ADET CASE QUANTITY
001 020 500001 05 XX	NO.1 PANO SİRALI (50cm)/NO.1 PANEL SPIRAL	5mm	6	100	4000
001 020 500002 05 XX	NO.2 PANO SİRALI (50cm)/NO.2 PANEL SPIRAL	7mm	8	100	3000
001 020 500003 05 XX	NO.3 PANO SİRALI (50cm)/NO.3 PANEL SPIRAL	10mm	11	100	2000
001 020 500004 05 XX	NO.4 PANO SİRALI (50cm)/NO.4 PANEL SPIRAL	13mm	14	50	800
001 020 500005 05 XX	NO.5 PANO SİRALI (50cm)/NO.5 PANEL SPIRAL	16mm	17	25	800



HELEZON PANO SİRALI (RULO)

HELICAL PANEL SPIRAL (ROLL)

KOD CODE	AÇIKLAMA DESCRIPTION	İÇ ÇAP INNER DIAMETER	DIŞ ÇAP OUTER DIAMETER	KUTU ADET BOX QUANTITY	KOLİ ADET CASE QUANTITY
001 020 600001 05 XX	NO.1 PANO SİRALI (100cm)/NO.1 PANEL SPIRAL	5mm	6mm	100	4000
001 020 600002 05 XX	NO.2 PANO SİRALI (100cm)/NO.2 PANEL SPIRAL	7mm	8mm	100	3000
001 020 600003 05 XX	NO.3 PANO SİRALI (100cm)/NO.3 PANEL SPIRAL	10mm	11mm	100	2000
001 020 600004 05 XX	NO.4 PANO SİRALI (100cm)/NO.4 PANEL SPIRAL	13mm	14mm	50	800
001 020 600005 05 XX	NO.5 PANO SİRALI (100cm)/NO.5 PANEL SPIRAL	16mm	17mm	50	800



PANO TOPRAKLAMA KLEMENSLERİ (6x8mm) 63A
PANEL GROUNDING STRAPS (6x8mm) 63A

KOD CODE	AÇIKLAMA DESCRIPTION	AMBALAJ PACKING	KUTU ADET QUANTITY	L	B	H
014 102 006304	4 DELİK PANO TOPRAKLAMA KLEMENS / 4 POINT PANEL GROUNDING STRAPS	KUTU / PACK	100	6	8	33
014 102 006305	5 DELİK PANO TOPRAKLAMA KLEMENS / 5 POINT PANEL GROUNDING STRAPS	KUTU / PACK	100	6	8	38
014 102 006306	6 DELİK PANO TOPRAKLAMA KLEMENS / 6 POINT PANEL GROUNDING STRAPS	KUTU / PACK	100	6	8	45
014 102 006307	7 DELİK PANO TOPRAKLAMA KLEMENS / 7 POINT PANEL GROUNDING STRAPS	KUTU / PACK	100	6	8	50
014 102 006309	9 DELİK PANO TOPRAKLAMA KLEMENS / 9 POINT PANEL GROUNDING STRAPS	KUTU / PACK	100	6	8	62
014 102 006310	10 DELİK PANO TOPRAKLAMA KLEMENS / 10 POINT PANEL GROUNDING STRAPS	KUTU / PACK	100	6	8	68
014 102 006312	12 DELİK PANO TOPRAKLAMA KLEMENS / 12 POINT PANEL GROUNDING STRAPS	KUTU / PACK	100	6	8	80



PANO TOPRAKLAMA KLEMENSLERİ AYAKLI (6,5x9mm) 80A
PANEL GROUNDING STRAPS (6,5x9mm) 80A

KOD CODE	AÇIKLAMA DESCRIPTION	AMBALAJ PACKING	KUTU ADET QUANTITY	L	B	H
014 102 008006	6 DELİK AYAKLI DAĞITIM ÜNİTESİ/ 6-HOLE FLOOR-STANDING DISTRIBUTION UNIT	KUTU / PACK	200	85	70	22
014 102 008010	10 DELİK AYAKLI DAĞITIM ÜNİTESİ/ 10-HOLE FLOOR-STANDING DISTRIBUTION UNIT	KUTU / PACK	150	108	95	22
014 102 008012	12 DELİK AYAKLI DAĞITIM ÜNİTESİ/ 12-HOLE FLOOR-STANDING DISTRIBUTION UNIT	KUTU / PACK	150	120	106	22
014 102 008015	15 DELİK AYAKLI DAĞITIM ÜNİTESİ/ 15-HOLE FLOOR-STANDING DISTRIBUTION UNIT	KUTU / PACK	125	138	124	22
014 102 008020	20 DELİK AYAKLI DAĞITIM ÜNİTESİ/ 20-HOLE FLOOR-STANDING DISTRIBUTION UNIT	KUTU / PACK	100	165	152	22

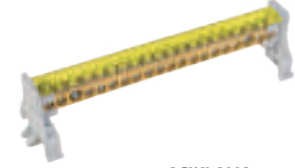

1 KUTUP DAĞITIM ÜNİTESİ 125A
1-POLE DISTRIBUTION UNIT 125A

KOD CODE	AÇIKLAMA DESCRIPTION	CİNSİ PACKING	AMBALAJ PACKING	KOLİ ADET QUANTITY	L	B	H
014 102 112507	125A 1 KUTUP DAĞITIM ÜNİTESİ / 125A 1-POLE DISTRIBUTION UNIT	2+5	KUTU / PACK	70	76	44	42
014 102 112510	125A 1 KUTUP DAĞITIM ÜNİTESİ / 125A 1-POLE DISTRIBUTION UNIT	2+8	KUTU / PACK	60	100	44	42
014 102 112512	125A 1 KUTUP DAĞITIM ÜNİTESİ / 125A 1-POLE DISTRIBUTION UNIT	2+10	KUTU / PACK	55	115	44	42
014 102 112515	125A 1 KUTUP DAĞITIM ÜNİTESİ / 125A 1-POLE DISTRIBUTION UNIT	2+13	KUTU / PACK	45	135	44	42
014 102 112520	125A 1 KUTUP DAĞITIM ÜNİTESİ / 125A 1-POLE DISTRIBUTION UNIT	2+18	KUTU / PACK	35	170	44	42
014 102 112522	125A 1 KUTUP DAĞITIM ÜNİTESİ / 125A 1-POLE DISTRIBUTION UNIT	2+20	KUTU / PACK	30	185	44	42

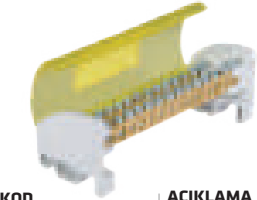

2 KUTUP DAĞITIM ÜNİTESİ 125A
2-POLE DISTRIBUTION UNIT 125A

KOD CODE	AÇIKLAMA DESCRIPTION	CİNSİ PACKING	AMBALAJ PACKING	KOLİ ADET QUANTITY	L	B	H
014 102 212507	125A 2 KUTUP DAĞITIM ÜNİTESİ / 125A 2-POLE DISTRIBUTION UNIT	2+5	KUTU / PACK	20	81	90	50
014 102 212510	125A 2 KUTUP DAĞITIM ÜNİTESİ / 125A 2-POLE DISTRIBUTION UNIT	2+8	KUTU / PACK	16	103	90	50
014 102 212512	125A 2 KUTUP DAĞITIM ÜNİTESİ / 125A 2-POLE DISTRIBUTION UNIT	2+10	KUTU / PACK	12	118	90	50
014 102 212515	125A 2 KUTUP DAĞITIM ÜNİTESİ / 125A 2-POLE DISTRIBUTION UNIT	2+13	KUTU / PACK	10	142	90	50
014 102 212520	125A 2 KUTUP DAĞITIM ÜNİTESİ / 125A 2-POLE DISTRIBUTION UNIT	2+18	KUTU / PACK	8	178	90	50



4 KUTUP DAĞITIM ÜNİTESİ 125A
4-POLE DISTRIBUTION UNIT 125A

KOD CODE	AÇIKLAMA DESCRIPTION	CİNSİ PACKING	AMBALAJ PACKING	KOLİ ADET QUANTITY	L	B	H
014 102 412507	125A 4 KUTUP DAĞITIM ÜNİTESİ / 125A 4-POLE DISTRIBUTION UNIT	2+5	KUTU / PACK	10	60	80	75
014 102 412510	125A 4 KUTUP DAĞITIM ÜNİTESİ / 125A 4-POLE DISTRIBUTION UNIT	2+8	KUTU / PACK	8	83	80	75
014 102 412512	125A 4 KUTUP DAĞITIM ÜNİTESİ / 125A 4-POLE DISTRIBUTION UNIT	2+10	KUTU / PACK	6	97	80	75
014 102 412515	125A 4 KUTUP DAĞITIM ÜNİTESİ / 125A 4-POLE DISTRIBUTION UNIT	2+13	KUTU / PACK	5	120	80	75
014 102 412520	125A 4 KUTUP DAĞITIM ÜNİTESİ / 125A 4-POLE DISTRIBUTION UNIT	2+18	KUTU / PACK	4	155	80	75
014 102 412522	125A 4 KUTUP DAĞITIM ÜNİTESİ / 125A 4-POLE DISTRIBUTION UNIT	2+20	KUTU / PACK	4	170	80	75
014 102 412525	125A 4 KUTUP DAĞITIM ÜNİTESİ / 125A 4-POLE DISTRIBUTION UNIT	2+23	KUTU / PACK	4	191	80	75

SWISS GEÇMELİ BUAT KLEMENS / SWISS INSERTABLE JUNCTION BOX TERMINAL

KOD CODE	ÜRÜN ADI PRODUCT NAME	AMBALAJ PACKING	ADET QUANTITY	AĞIRLIK WEIGHT	HACİM VOLUME
999 094 225000	2'Lİ (0,5-2,5 mm ²)	KUTU PACK	100	-	-
999 094 325000	3'LÜ (0,5-2,5 mm ²)	KUTU PACK	100	-	-
999 094 425000	4'LÜ (0,5-2,5 mm ²)	KUTU PACK	100	-	-
999 094 525000	5'Lİ (0,5-2,5 mm ²)	KUTU PACK	100	-	-
999 094 625000	6-Lİ (0,5-2,5 mm ²)	KUTU PACK	50	-	-
999 094 825000	8-Lİ (0,5-2,5 mm ²)	KUTU PACK	50	-	-



SWISS TIRNAKLI BUAT KLEMENS / SWISS CLAWED JUNCTION BOX TERMINAL

KOD CODE	ÜRÜN ADI PRODUCT NAME	AMBALAJ PACKING	ADET QUANTITY	AĞIRLIK WEIGHT	HACİM VOLUME
999 094 241000	2'Lİ (0,5-2,5 mm ²)	KUTU PACK	100	-	-
999 094 341000	3'LÜ (0,5-2,5 mm ²)	KUTU PACK	100	-	-
999 094 441000	4'LÜ (0,5-2,5 mm ²)	KUTU PACK	50	-	-
999 094 541000	5'Lİ (0,5-2,5 mm ²)	KUTU PACK	50	-	-



BUAT KLEMENS / JUNCTION BOX TERMINAL

KOD CODE	ÜRÜN ADI PRODUCT NAME	AMBALAJ PACKING	ADET QUANTITY	AĞIRLIK WEIGHT	HACİM VOLUME
015 094 160001	NO. 2 ZEYTİN (BUAT) KLEMENS	KUTU PACK	1000	-	-



ŞEFFAF ISIYA DAYANIKLI BUAT KLEMENS / TRANSPARENT HEAT-RESISTANT JUNCTION BOX TERMINAL

KOD CODE	ÜRÜN ADI PRODUCT NAME	AMBALAJ PACKING	ADET QUANTITY	AĞIRLIK WEIGHT	HACİM VOLUME
888 094 000105	NO.2	KUTU PACK	-	-	-
888 094 000205	NO.3	KUTU PACK	-	-	-
888 094 000405	NO.4	KUTU PACK	-	-	-
888 094 000605	NO.5	KUTU PACK	-	-	-



GEÇMELİ SOKET KLEMENS / PLUG-IN SOCKET TERMINAL

KOD CODE	ÜRÜN ADI PRODUCT NAME	AMBALAJ PACKING	ADET QUANTITY	AĞIRLIK WEIGHT	HACİM VOLUME
999 999 991212	12'Lİ GEÇMELİ SOKET KLEMENS	KUTU PACK	25	-	-



PLASTİK SIRA KLEMENS / PLASTIC ROW TERMINAL

KOD CODE	ÜRÜN ADI PRODUCT NAME	AMBALAJ PACKING	ADET QUANTITY	AĞIRLIK WEIGHT	HACİM VOLUME
015 094 150001	NO. 1 (2,5-4 mm ²)	KUTU PACK	50	-	-
015 094 150002	NO. 2 (4-6 mm ²)	KUTU PACK	50	-	-
015 094 150003	NO. 3 (6-10 mm ²)	KUTU PACK	50	-	-
015 094 150004	NO. 4 (10-16 mm ²)	KUTU PACK	50	-	-
015 094 150005	NO. 5 (16-25 mm ²)	KUTU PACK	50	-	-



ISIYA DAYANIKLI SIRA KLEMENS/ HEAT-RESISTANT TERMINAL BLOCK STRIP

KOD CODE	ÜRÜN ADI PRODUCT NAME	AMBALAJ PACKING	ADET QUANTITY	AĞIRLIK WEIGHT	HACİM VOLUME
015 094 170001	NO. 1 (2,5-4 mm ²)	KUTU PACK	50	-	-
015 094 170002	NO. 2 (4-6 mm ²)	KUTU PACK	50	-	-
015 094 170003	NO. 3 (6-10 mm ²)	KUTU PACK	50	-	-
015 094 170004	NO. 4 (10-16 mm ²)	KUTU PACK	50	-	-
015 094 170005	NO. 5 (16-25 mm ²)	KUTU PACK	50	-	-



PORSELEN KLEMENS/ PORCELAIN TERMINAL

KOD CODE	ÜRÜN ADI PRODUCT NAME	AMBALAJ PACKING	ADET QUANTITY	AĞIRLIK WEIGHT	HACİM VOLUME
015 094 180002	NO. 1-2 (2,5-4 mm ²)	KUTU PACK	50	-	-
015 094 180003	NO. 1-3 (2,5-4 mm ²)	KUTU PACK	50	-	-
015 094 180004	NO. 2-2 (4-6 mm ²)	KUTU PACK	50	-	-
015 094 180005	NO. 2-3 (4-6 mm ²)	KUTU PACK	50	-	-
015 094 180006	NO. 3-2 (6-10 mm ²)	KUTU PACK	50	-	-
015 094 180007	NO. 3-3 (6-10 mm ²)	KUTU PACK	50	-	-



U KLEMENSLER/ U TERMINALS

KOD CODE	ÜRÜN ADI PRODUCT NAME	AMBALAJ PACKING	ADET QUANTITY	AĞIRLIK WEIGHT	HACİM VOLUME
014 094 030006	6'LİK U KLEMENS	KUTU PACK	300	-	-
014 094 030010	10'LÜK U KLEMENS	KUTU PACK	250	-	-
014 094 030016	16'LİK U KLEMENS	KUTU PACK	100	-	-
014 094 030025	25'LİK U KLEMENS	KUTU PACK	100	-	-
014 094 030035	35'LİK U KLEMENS	KUTU PACK	75	-	-
014 094 030050	50'LİK U KLEMENS	KUTU PACK	50	-	-
014 094 030070	70'LİK U KLEMENS	KUTU PACK	40	-	-
014 094 030095	95'LİK U KLEMENS	KUTU PACK	25	-	-
014 094 030120	120'LİK U KLEMENS	KUTU PACK	20	-	-
014 094 030150	150'LİK U KLEMENS	KUTU PACK	15	-	-





İZOLELİ KABLO YÜKSÜKLERİ TEK GİRİŞ FRANSIZ - ALMAN NORMLARI
CORD END TERMINALS - SINGLE

KOD CODE	MODEL KODU MODEL CODE	EBATLAR DIMENSIONS					KABLO KESİTİ CABLE SECTION	AMBALAJ PACKING	RENK COLOR		ADET QUANTITY
		F	L	W	DØ	CØ			FRANSIZ	ALMAN	
014 100 X10258	ITYX-0258	8.0	12.5	2.5	1.0	0.7	0.25	KUTU PACK	Menekşe	Mavi	1.000
014 100 X10348	ITYX-0348	8.0	12.5	2.5	1.1	0.8	0.34	KUTU PACK	Pembe	Turkuaz	1.000
014 100 X10508	ITYX-0508	8.0	14.0	2.6	1.3	1.0	0.50	KUTU PACK	Beyaz	Turuncu	1.000
014 100 X17508	ITYX-7508	8.0	14.6	2.8	1.6	1.3	0.75	KUTU PACK	Mavi	Beyaz	1.000
014 100 X11008	ITYX-1008	8.0	14.6	3.0	1.8	1.5	1.0	KUTU PACK	Kırmızı	Sarı	1.000
014 100 X11508	ITYX-1508	8.0	16.4	3.5	2.1	1.8	1.5	KUTU PACK	Siyah	Kırmızı	1.000
014 100 X12508	ITYX-2508	8.0	15.2	4.0	2.6	2.3	2.5	KUTU PACK	Gri	Mavi	500
014 100 X14009	ITYX-4009	9.0	16.5	4.4	3.2	2.8	4.0	KUTU PACK	Turuncu	Gri	500
014 100 X16012	ITYX-6012	12.0	20.0	6.3	3.9	3.5	6.0	KUTU PACK	Yeşil	Siyah	250
014 100 X11012	ITYX-1012	12.0	21.5	7.6	4.9	4.5	10.0	KUTU PACK	Kahverengi	Bej	100
014 100 X11612	ITYX-1612	12.0	22.2	8.8	6.2	5.8	16.0	KUTU PACK	Bej	Yeşil	100
014 100 X12516	ITYX-2516	16.0	29.0	11.2	7.9	7.5	25.0	KUTU PACK	Siyah	Kahverengi	50
014 100 X13516	ITYX-3516	16.0	30.0	12.7	8.7	8.3	35.0	KUTU PACK	Kırmızı	Bej	25
014 100 X15020	ITYX-5020	20.0	36.0	15.3	10.9	10.3	50.0	KUTU PACK	Mavi	Yeşil	25
014 100 017020	ITYF-7020	20.0	37.0	16.0	14.3	13.5	70.0	KUTU PACK	Sarı	-	25

X= 0 Fransız (French) X= F Fransız (French)
X= 2 Alman (German) X=A Alman (German)

Standart / Standard : DIN 46228
Malzeme / Materials : Bakır / Copper
İzolasyon / Insulation : Nylon
Voltaj / Voltage : <600V
Çalışma Sıcaklığı / Working Temp. : Max. 105°

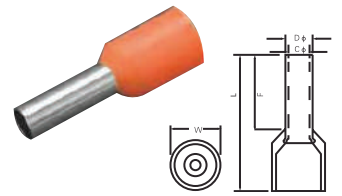

İZOLELİ KABLO YÜKSÜKLERİ ÇİFT GİRİŞ FRANSIZ - ALMAN NORMLARI
CORD END TERMINALS - TWIN

KOD CODE	MODEL KODU MODEL CODE	EBATLAR DIMENSIONS					KABLO KESİTİ CABLE SECTION	AMBALAJ PACKING	RENK COLOR		ADET QUANTITY	
		F	L	W	B	DØ			CØ	FRANSIZ		ALMAN
014 100 X20508	ICYX-0508	8.0	12.5	5.0	6.5	1.8	1.5	2x0.5	KUTU PACK	Beyaz	Turuncu	1.000
014 100 X27508	ICYX-7508	8.0	12.5	5.5	6.7	2.1	1.8	2x0.75	KUTU PACK	Mavi	Beyaz	500
014 100 X21008	ICYX-1008	8.0	14.0	5.5	7.1	2.3	2.0	2x1.0	KUTU PACK	Kırmızı	Sarı	500
014 100 X21508	ICYX-1508	8.0	14.6	6.4	7.2	2.6	2.3	2x1.5	KUTU PACK	Siyah	Kırmızı	500
014 100 X22510	ICYX-2510	10.0	14.6	8.0	8.5	3.3	2.9	2x2.5	KUTU PACK	Gri	Mavi	250
014 100 X24012	ICYX-4012	12.0	16.4	8.8	11.1	4.2	3.8	2x4.0	KUTU PACK	Turuncu	Gri	200
014 100 X26014	ICYX-6014	14.0	15.2	9.5	12.1	5.3	4.9	2x6.0	KUTU PACK	Yeşil	Siyah	100
014 100 X21014	ICYX-1014	14.0	16.5	12.6	12.0	6.9	6.5	2x10.0	KUTU PACK	Kahverengi	Bej	50
014 100 X21614	ICYX-1614	14.0	20.0	19.0	17.3	8.7	8.3	2x16.0	KUTU PACK	Bej	Yeşil	50

X= 0 Fransız (French) X= F Fransız (French)
X= 2 Alman (German) X=A Alman (German)

Standart / Standard : DIN 46228
Malzeme / Materials : Bakır / Copper
İzolasyon / Insulation : Nylon
Voltaj / Voltage : <600V
Çalışma Sıcaklığı / Working Temp. : Max. 105°

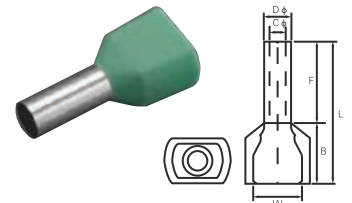

İZOLESİZ KABLO YÜKSÜKLERİ TEK GİRİŞ / NON-INSULATING CORD END TERMINALS - SINGLE

KOD CODE	MODEL KODU MODEL CODE	EBATLAR DIMENSIONS				KABLO KESİTİ PACKING	AMBALAJ PACKING	ADET QUANTITY
		L	W	DØ	CØ			
014 100 120510	KTY-0508	10.0	1.7	1.3	1.0	0.50	KUTU PACK	2.000
014 100 127510	KTY-7508	10.0	1.9	1.6	1.3	0.75	KUTU PACK	1.000
014 100 121010	KTY-1008	10.0	2.2	1.8	1.5	1.0	KUTU PACK	1.000
014 100 121510	KTY-1508	10.0	2.5	2.1	1.8	1.5	KUTU PACK	1.000
014 100 122512	KTY-2508	12.0	3.3	2.6	2.3	2.5	KUTU PACK	1.000
014 100 124012	KTY-4009	12.0	3.9	3.2	2.8	4.0	KUTU PACK	1.000
014 100 126012	KTY-6012	12.0	4.8	3.9	3.5	6.0	KUTU PACK	500
014 100 121015	KTY-1012	15.0	5.8	4.9	4.5	10.0	KUTU PACK	250
014 100 121615	KTY-1612	15.0	7.2	6.2	5.8	16.0	KUTU PACK	250
014 100 122516	KTY-2516	16.0	9.1	7.9	7.5	25.0	KUTU PACK	100
014 100 123516	KTY-3516	16.0	10.2	8.7	8.3	35.0	KUTU PACK	100
014 100 125020	KTY-5020	20.0	12.4	10.9	10.3	50.0	KUTU PACK	50

Standart / Standard : DIN 46228
Malzeme / Materials : Bakır / Copper
Voltaj / Voltage : <600V
Çalışma Sıcaklığı / Working Temp. : Max. 105°

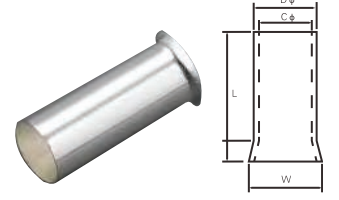

İZOLELİ KABLO YÜKSÜKLERİ TİP PABUÇ / PRE-INSULATED RING TERMINALS

KOD CODE	MODEL KODU MODEL CODE	EBATLAR DIMENSIONS					CİVATA ÇAP (d2) mm BOLT DIA	AMBALAJ PACKING	KABLO KESİTİ CABLE SECTION	RENK COLOR	ADET QUANTITY
		B	F	L	E	DØ					
014 100 030153	IYP-1,5-3	5.7	4.95	17.8	10.0	4.3	3.2	KUTU PACK	0.5 -1.5 mm ² 19A	Kırmızı	200
014 100 030154	IYP-1,5-4	8.0	7.0	21.0	10.0	4.3	4.3	KUTU PACK			200
014 100 030155	IYP-1,5-5	9.5	8.5	22.2	10.0	4.3	5.3	KUTU PACK			200
014 100 030156	IYP-1,5-6	11.6	11.1	27.0	10.0	4.3	6.5	KUTU PACK			200
014 100 030158	IYP-1,5-8	11.6	11.1	27.0	10.0	4.3	8.5	KUTU PACK			200
014 100 030253	IYP-2,5-3	6.6	4.8	17.8	10.0	4.9	3.2	KUTU PACK	1.5 -2.5 mm ² 27A	Mavi	200
014 100 030254	IYP-2,5-4	8.5	7.4	21.7	10.0	4.9	4.3	KUTU PACK			200
014 100 030255	IYP-2,5-5	9.5	7.4	22.5	10.0	4.9	5.3	KUTU PACK			200
014 100 030256	IYP-2,5-6	12.0	11.0	27.0	10.0	4.9	6.5	KUTU PACK			200
014 100 030258	IYP-2,5-8	12.0	11.0	27.0	10.0	4.9	8.5	KUTU PACK			200
014 100 032510	IYP-2,5-10	13.6	13.9	30.7	10.0	4.9	10.5	KUTU PACK			200
014 100 036004	IYP-6-4	9.5	8.3	26.0	13.0	6.7	4.3	KUTU PACK	4 -6 mm ² 48A	Sarı	100
014 100 036005	IYP-6-5	9.5	8.3	26.0	13.0	6.7	5.3	KUTU PACK			100
014 100 036006	IYP-6-6	12.0	10.5	29.5	13.0	6.7	6.5	KUTU PACK			100
014 100 036008	IYP-6-8	15.0	13.7	35.0	13.0	6.7	8.5	KUTU PACK			100
014 100 036010	IYP-6-10	15.0	13.7	35.0	13.0	6.7	10.5	KUTU PACK			100
014 100 036012	IYP-6-12	19.2	16.0	39.4	13.0	6.7	13.0	KUTU PACK			100

Standart / Standard : DIN 46228
Malzeme / Materials : Bakır / Copper
İzolasyon / Insulation : PVC
Voltaj / Voltage : <600V
Çalışma Sıcaklığı / Working Temp. : Max. 105°

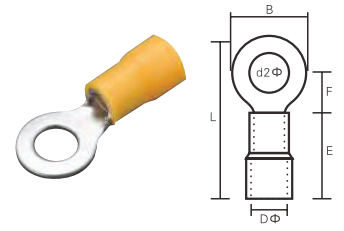

İZOLELİ KABLO YÜKSÜKLERİ TİP PABUÇ / PRE-INSULATING FORK TERMINALS

KOD CODE	MODEL KODU MODEL CODE	EBATLAR DIMENSIONS					CİVATA ÇAP (d2) mm BOLT DIA	AMBALAJ PACKING	KABLO KESİTİ CABLE SECTION	RENK COLOR	ADET QUANTITY		
		B	F	L	H	DØ							
014 100 040153	ICP-1,5-3	5.7	6.5	21.2	10.0	4.3	3.2	KUTU PACK	0.5 -1.5 mm ² 19A	Kırmızı	200		
014 100 040154	ICP-1,5-4	8.1	6.5	21.2	10.0	4.3	4.3	KUTU PACK			200		
014 100 040155	ICP-1,5-5	9.5	6.5	21.2	10.0	4.3	5.3	KUTU PACK			200		
014 100 040156	ICP-1,5-6	12.0	11.0	27.2	10.0	4.3	6.5	KUTU PACK			200		
014 100 040253	ICP-2,5-3	5.7	6.5	21.2	10.0	4.9	3.2	KUTU PACK			1.5 -2.5 mm ² 27A	Mavi	200
014 100 040254	ICP-2,5-4	8.1	6.5	21.2	10.0	4.9	4.3	KUTU PACK	200				
014 100 040255	ICP-2,5-5	9.5	6.5	21.2	10.0	4.9	5.3	KUTU PACK	200				
014 100 040256	ICP-2,5-6	12.0	11.0	27.2	10.0	4.9	6.5	KUTU PACK	200				
014 100 046004	ICP-6-4	9.0	7.5	26.5	13.0	6.7	4.3	KUTU PACK	4 -6 mm ² 48A	Sarı			100
014 100 046005	ICP-6-5	9.0	7.5	26.5	13.0	6.7	5.3	KUTU PACK					100
014 100 046006	ICP-6-6	12.0	12.0	32.5	13.0	6.7	6.5	KUTU PACK			100		
014 100 046008	ICP-6-8	14.0	11.5	31.5	13.0	6.7	8.5	KUTU PACK			100		

Standart / Standard : DIN 46228
Malzeme / Materials : Bakır / Copper
İzolasyon / Insulation : PVC
Voltaj / Voltage : <600V
Çalışma Sıcaklığı / Working Temp. : Max. 105°

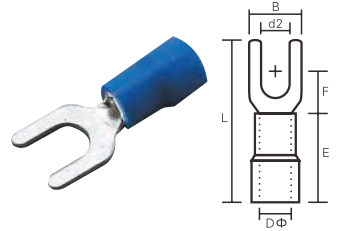

TAM İZOLELİ FASTON DIŞI TERMİNAL / FULL-INSULATING FEMALE TERMINALS

KOD CODE	MODEL KODU MODEL CODE	EBATLAR DIMENSIONS					SOKET ÖLÇÜSÜ NEMA TAB	KALINLIK (mm) THICKNESS	AMBALAJ PACKING	KABLO KESİTİ CABLE SECTION	RENK COLOR	ADET QUANTITY
		B	DØ	dØ	L	E						
014 100 090508	TDT-0,5-1/2.8	3.3	3.8	1.7	20.0	10.0	0.5x2.8	0.30	KUTU PACK	0.5 -1.5 mm ² 19A	Kırmızı	200
014 100 090509	TDT-0,5-1/4.8	5.0	3.8	1.7	20.5	10.0	0.8x4.75	0.35	KUTU PACK			200
014 100 090510	TDT-0,5-1/6.4	6.6	3.8	1.7	22.4	10.0	0.8x6.35	0.40	KUTU PACK			200
014 100 091523	TDT-1,5-2,5/2.8	3.3	4.3	2.3	20.0	10.0	0.8x2.8	0.30	KUTU PACK	1.5 -2.5 mm ² 27A	Mavi	200
014 100 091524	TDT-1,5-2,5/4.8	5.0	4.3	2.3	20.5	10.0	0.8x4.75	0.35	KUTU PACK			200
014 100 091525	TDT-1,5-2,5/6.4	6.6	4.3	2.3	22.7	10.0	0.8x6.35	0.40	KUTU PACK			200
014 100 094060	TDT-4-6	6.6	5.7	3.4	23.0	12.5	0.8x6.35	0.40	KUTU PACK			4 -6 mm ² 48A

Malzeme / Materials : Pirinç / Brass
İzolasyon / Insulation : PVC
Voltaj / Voltage : <600V
Çalışma Sıcaklığı / Working Temp. : Max. 75°

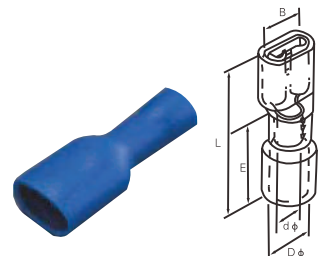

TAM İZOLELİ FASTON DIŞI TERMİNAL / FULL-INSULATING BULLET FEMALE TERMINALS

KOD CODE	MODEL KODU MODEL CODE	EBATLAR DIMENSIONS					KALINLIK (mm) THICKNESS	AMBALAJ PACKING	KABLO KESİTİ CABLE SECTION	RENK COLOR	ADET QUANTITY
		B	F	DØ	E	L					
014 100 100510	YDT-0,5-1	4.0	7.0	1.7	10.5	23.3	0.30	KUTU PACK	0.5-1.5 mm ² 19A	Kırmızı	200
014 100 101525	YDT-1,5-2,5	5.0	7.0	2.3	10.5	25.1	0.40	KUTU PACK	1.5-2.5 mm ² 27A	Mavi	200
014 100 104060	YDT-4-6	5.0	7.0	3.4	12.5	25.1	0.35	KUTU PACK	4-6 mm ² 48A	Sarı	200

Malzeme / Materials : Pirinç / Brass
İzolasyon / Insulation : PVC
Voltaj / Voltage : <600V
Çalışma Sıcaklığı / Working Temp. : Max. 75°

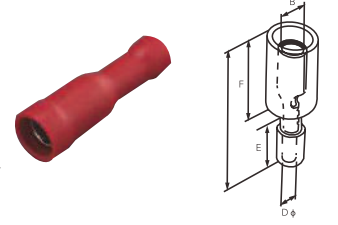

İZOLELİ EK MUF / LONG TYPE MIDDLE CONNECTOR

KOD CODE	MODEL KODU MODEL CODE	EBATLAR DIMENSIONS				MAKSİMUM AKIM MAXIMUM CURRENT	AMBALAJ PACKING	KABLO KESİTİ CABLE SECTION	RENK COLOR	ADET QUANTITY
		I	dØ	DØ	L					
014 100 070015	IEM-1,5	15.0	1.7	4.3	25.0	19A	KUTU PACK	0.5-1.5 mm ²	Kırmızı	200
014 100 070025	IEM-2,5	15.0	2.3	4.9	25.0	27A	KUTU PACK	1.5-2.5 mm ²	Mavi	200
014 100 070040	IEM-4	15.0	3.4	6.7	25.0	48A	KUTU PACK	4-6 mm ²	Sarı	100

Standart / Standard : DIN 46228
Malzeme / Materials : Bakır / Copper
İzolasyon / Insulation : PVC
Voltaj / Voltage : <600V
Çalışma Sıcaklığı / Working Temp. : Max. 105°

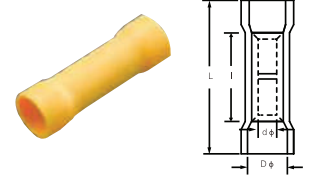

İZOLELİ FASTON ERKEK TERMİNAL / PRE-INSULATING MALE TERMINALS

KOD CODE	MODEL KODU MODEL CODE	EBATLAR DIMENSIONS					SOKET ÖLÇÜSÜ NEMA TAB	KALINLIK (mm) THICKNESS	AMBALAJ PACKING	KABLO KESİTİ CABLE SECTION	RENK COLOR	ADET QUANTITY
		B	DØ	dØ	L	E						
014 100 060013	IFE-1,5/2.8	2.8	1.7	3.8	17.7	10.0	0.8x2.8	0.8	KUTU PACK	0.5-1.5 mm ² 19A		
014 100 060014	IFE-1,5/4.8	4.8	1.7	3.8	20.0	10.0	0.4x4.75	0.4x2	KUTU PACK			
014 100 060015	IFE-1,5/6.4	6.4	1.7	3.8	21.0	10.0	0.8x6.35	0.4x2	KUTU PACK			
014 100 060023	IFE-2,5/2.8	2.8	2.3	4.3	17.7	10.0	0.8x2.8	0.8	KUTU PACK	1.5-2.5 mm ² 27A		
014 100 060024	IFE-2,5/4.8	4.8	2.3	4.3	20.0	10.0	0.4x4.75	0.4x2	KUTU PACK			
014 100 060025	IFE-2,5/6.4	6.4	2.3	4.3	21.0	10.0	0.8x6.35	0.4x2	KUTU PACK			
014 100 060040	IFE-4	6.4	3.4	5.7	23.0	12.5	0.8x6.35	0.4x2	KUTU PACK	4-6 mm ² 48A		

Malzeme / Materials : Pirinç / Brass
İzolasyon / Insulation : PVC
Voltaj / Voltage : <600V
Çalışma Sıcaklığı / Working Temp. : Max. 75°

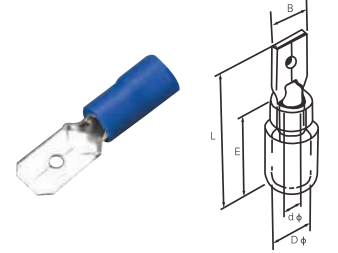

YUVARLAK ERKEK TERMİNAL / PRE-INSULATING BULLET MALE TERMINALS

KOD CODE	MODEL KODU MODEL CODE	EBATLAR DIMENSIONS					KALINLIK (mm) THICKNESS	AMBALAJ PACKING	KABLO KESİTİ CABLE SECTION	RENK COLOR	ADET QUANTITY
		B	F	DØ	E	L					
014 100 110510	YET-0,5-1	4.0	8.5	1.7	10.5	21.5	0.4	KUTU PACK	0.5-1.5 mm ² 19A	Kırmızı	200
014 100 111525	YET-1,5-2,5	5.0	8.5	2.3	10.5	21.7	0.4	KUTU PACK	1.5-2.5 mm ² 27A	Mavi	200
014 100 114060	YET-4-6	5.0	8.5	3.4	13.0	24.0	0.4	KUTU PACK	4-6 mm ² 48A	Sarı	200

Malzeme / Materials : Pirinç / Brass
İzolasyon / Insulation : PVC
Voltaj / Voltage : <600V
Çalışma Sıcaklığı / Working Temp. : Max. 75°

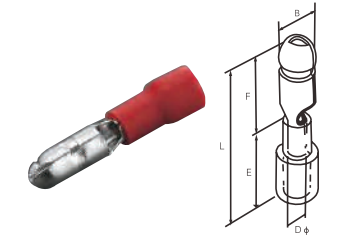

İZOLELİ İĞNE TİP TERMİNAL / PRE-INSULATING PIN TERMINALS

KOD CODE	MODEL KODU MODEL CODE	EBATLAR DIMENSIONS					KALINLIK (mm) THICKNESS	AMBALAJ PACKING	KABLO KESİTİ CABLE SECTION	RENK COLOR	ADET QUANTITY
		B	F	L	E	DØ					
014 100 050015	IIT-1,5	1.9	10.0	20.0	10.0	4.3	0.7	KUTU PACK	0.5-1.5 mm ² 19A	Kırmızı	200
014 100 050025	IIT-2,5	1.9	12.0	22.0	10.0	4.9	0.8	KUTU PACK	1.5-2.5 mm ² 27A	Mavi	200
014 100 050040	IIT-4	1.9	13.0	26.8	13.0	6.7	1.0	KUTU PACK	4-6 mm ² 48A	Sarı	100

Malzeme / Materials : Bakır / Copper
İzolasyon / Insulation : PVC
Voltaj / Voltage : <600V
Çalışma Sıcaklığı / Working Temp. : Max. 105°

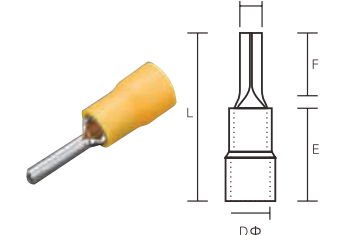

TAM İZOLELİ FASTON DIŞI TERMİNAL / PRE-INSULATING FEMALE TERMINALS

KOD CODE	MODEL KODU MODEL CODE	EBATLAR DIMENSIONS				SOKET ÖLÇÜSÜ NEMA TAB	KALINLIK (mm) THICKNESS	AMBALAJ PACKING	KABLO KESİTİ CABLE SECTION	RENK COLOR	ADET QUANTITY	
		B	DØ	dØ	L							E
014 100 080508	IDT-0,5-1/2.8	3.3	3.8	1.7	18.5	10.0	0.8x2.8	0.30	KUTU PACK	Kırmızı	200	
014 100 080509	IDT-0,5-1/4.8	5.0	3.8	1.7	19.0	10.0	0.8x4.75	0.35	KUTU PACK		0.5-1.5 mm ² 10A	200
014 100 080510	IDT-0,5-1/6.4	6.6	3.8	1.7	19.8	10.0	0.8x6.35	0.40	KUTU PACK		1.5-2.5 mm ² 15A	200
014 100 081523	IDT-1,5-2,5/2.8	3.3	4.3	2.3	18.5	10.0	0.8x2.8	0.30	KUTU PACK	Mavi	200	
014 100 081524	IDT-1,5-2,5/4.8	5.0	4.3	2.3	19.0	10.0	0.8x4.75	0.35	KUTU PACK		1.5-2.5 mm ² 15A	200
014 100 081525	IDT-1,5-2,5/6.4	6.6	4.3	2.3	19.0	10.0	0.8x6.35	0.40	KUTU PACK		4-6 mm ² 24A	200
014 100 084060	IDT-4-6	6.6	5.7	3.4	23.4	12.5	0.8x6.35	0.40	KUTU PACK	Sarı	100	

Malzeme / Materials : Bakır / Copper
İzolasyon / Insulation : PVC
Voltaj / Voltage : <600V
Çalışma Sıcaklığı / Working Temp. : Max. 105°

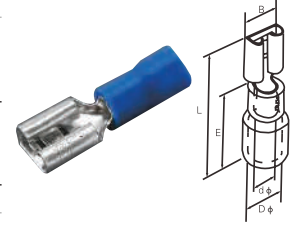

İZOLELİ ERKEK - DIŞI TERMİNAL / PRE-INSULATING PIGGY BACK MALE FEMALE TERMINALS

KOD CODE	MODEL KODU MODEL CODE	EBATLAR DIMENSIONS					SOKET ÖLÇÜSÜ NEMA TAB	AMBALAJ PACKING	KABLO KESİTİ CABLE SECTION	RENK COLOR	ADET QUANTITY	
		B	B1	E	DØ	dØ						L
014 100 130515	IEDT-0,5-1,5	6.6	6.35	10.0	3.8	1.7	22.5	0.8x6.35	KUTU PACK	0.5-1.5 mm ² 10A	Kırmızı	100
014 100 131525	IEDT-1,5-2,5	6.6	6.35	10.0	4.3	2.3	22.5	0.8x6.35	KUTU PACK	1.5-2.5 mm ² 15A	Mavi	100
014 100 134060	IEDT-4-6	6.6	6.35	10.0	5.7	3.4	24.0	0.8x6.35	KUTU PACK	4-6 mm ² 24A	Sarı	100

Malzeme / Materials : Pirinç / Brass
İzolasyon / Insulation : PVC
Voltaj / Voltage : <600V
Çalışma Sıcaklığı / Working Temp. : Max. 75°

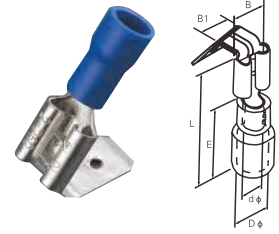

TAM İZOLELİ FASTON EĞİK DIŞI TERMİNAL / FULL-INSULATING FLAG FEMALE TERMINALS

KOD CODE	MODEL KODU MODEL CODE	EBATLAR DIMENSIONS				SOKET ÖLÇÜSÜ NEMA TAB	AMBALAJ PACKING	KABLO KESİTİ CABLE SECTION	RENK COLOR	ADET QUANTITY
		B	F	L	E					
014 100 130515	TEDT-0,5-1,5	6.6	7.6	16.0	1.7	0.8x4.75	KUTU PACK	0.5-1.5 mm ² 10A	Kırmızı	100
014 100 131525	TEDT-1,5-2,5	6.6	7.6	16.0	2.3	0.8x6.35	KUTU PACK	1.5-2.5 mm ² 15A	Mavi	100
014 100 134060	TEDT-4-6	7.0	7.6	17.5	3.4	0.8x6.35	KUTU PACK	4-6 mm ² 24A	Sarı	100

Malzeme / Materials : Pirinç / Brass
İzolasyon / Insulation : Naylon
Voltaj / Voltage : <600V
Çalışma Sıcaklığı / Working Temp. : Max. 75°

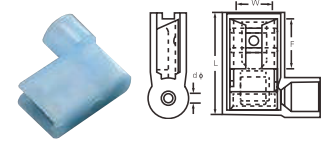

POLYAMİD TAM İZOLELİ DIŞI TERMİNAL / POLYAMIDE FEMALE TERMINALS

KOD CODE	MODEL KODU MODEL CODE	EBATLAR DIMENSIONS					SOKET ÖLÇÜSÜ NEMA TAB	AMBALAJ PACKING	RENK COLOR	ADET QUANTITY	
		W	F	L	B	DØ					CØ
014 100 150510	TDTP-0,5-1/6.4	8.4	10.5	22.6	11.0	4.0	1.7	0.8x6.35	KUTU PACK	Kırmızı	200
014 100 151525	TDTP-1,5-2,5/6.4	8.4	10.5	22.6	11.0	4.5	2.3	0.8x6.35	KUTU PACK	Mavi	200
014 100 154060	TDTP-4-6	8.6	10.5	24.0	13.0	6.3	3.4	0.8x6.35	KUTU PACK	Sarı	100

Malzeme / Materials : Pirinç / Brass
İzolasyon / Insulation : PVC
Voltaj / Voltage : <600V
Çalışma Sıcaklığı / Working Temp. : Max. 75°

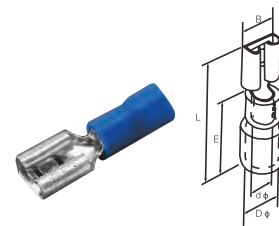

FASTON TİP TERMİNALLER İZOLESİZ

KOD CODE	ÜRÜN ADI MODEL NAME	AMBALAJ PACKING	ADET QUANTITY
065 100 140002	TSF-1-D MİNİ 4,8 FASTON TİP TERMİNAL	KUTU PACK	500
065 100 140003	TSF-1-D 6,3 FASTON TİP TERMİNAL İZOLESİZ	KUTU PACK	300
065 100 140004	TSF-1-E FASTON TİP TERMİNAL	KUTU PACK	300



BARALAR VE RAYLAR BUSBARS AND RAILS



TOPRAKLAMA BARASI VE MESNEDİ EARTHING ROD

KOD CODE	AÇIKLAMA DESCRIPTION	AMBALAJ PACKING	ADET QANTITY	AĞIRLIK WEIGHT	HACİM VOLUME
034 025 040000	TOPRAKLAMA BARASI 1,5 mm (31 VİDA) EARTHING BUSBAR 1,5mm (31 SCREWS)	KUTU PACK	40	-	-
034 025 100001	TOPRAKLAMA BARASI MESNEDİ EARTHING ROD	KUTU PACK	100	-	-

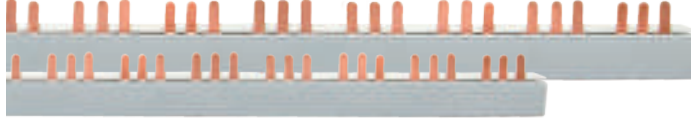

TRİFAZE BARALAR THREE PHASE BUSBARS

KOD CODE	AÇIKLAMA DESCRIPTION	AMBALAJ PACKING	ADET QANTITY	AĞIRLIK WEIGHT	HACİM VOLUME
034 025 040004	TRİFAZE MÜŞTEREK BARA İÇNE UÇLU 80A - 53 cm THREE PHASE COMMON BUSBAR, PINTLE TYPE, 53cm 80A	KUTU PACK	24	6,432	0,0072
034 025 040005	TRİFAZE MÜŞTEREK BARA İÇNE UÇLU 63A - 53 cm THREE PHASE COMMON BUSBAR, PINTLE TYPE, 53cm 63A	KUTU PACK	24	7,464	0,006864
034 025 040006	TRİFAZE MÜŞTEREK BARA İÇNE UÇLU 80A - 106 cm THREE PHASE COMMON BUSBAR, PINTLE TYPE, 106cm 80A	KUTU PACK	24	12,96	0,0144
034 025 040007	TRİFAZE MÜŞTEREK BARA İÇNE UÇLU 63A - 106 cm THREE PHASE COMMON BUSBAR, PINTLE TYPE, 106cm 63A	KUTU PACK	24	12,96	0,0144

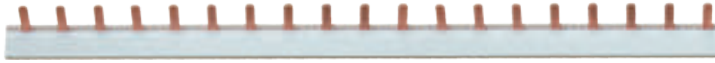

MONOFAZE BARALAR MONO PHASE BUSBARS

KOD CODE	AÇIKLAMA DESCRIPTION	AMBALAJ PACKING	ADET QANTITY	AĞIRLIK WEIGHT	HACİM VOLUME
034 025 040002	MONOFAZE MÜŞTEREK BARA İÇNE UÇLU 106cm THREE PHASE COMMON BUSBAR, PINTLE TYPE, 106cm	KUTU PACK	50	10,920kg	0,01030
034 025 040003	MONOFAZE MÜŞTEREK BARA İÇNE UÇLU 53 cm NO:1 CABLE STRAP WITH CONCRETE NAIL / 0,75 FLAT CORD CABLE STRAP	KUTU PACK	50	-	-

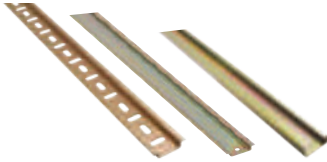

RAYLAR GROUNDING ROD

KOD CODE	AÇIKLAMA DESCRIPTION	AMBALAJ PACKING	ADET PACKING	AĞIRLIK WEIGHT	HACİM VOLUME
001 025 020100 00 00	KLEMENS RAYI (1m) WIRE CONNECTOR RAIL, 1m	KUTU PACK	25	13,375kg	0,00635
001 025 000100 00 00	W OTOMAT RAYI (1m) FUSE BOX RAIL, 1m	KUTU PACK	50	15,750kg	0,01500
001 025 000200 00 00	W OTOMAT RAYI (2m) FUSE BOX RAIL, 2m	KUTU PACK	50	-	-
001 025 000033 00 00	W OTOMAT RAYI (33 cm) FUSE BOX RAIL, 33cm	KUTU PACK	50	6,358kg	0,00500
001 025 900100 00 00	W OTOMAT RAYI (DELİKLİ)(1m) FUSE BOX RAIL (SLOTTED) 1m	KUTU PACK	50	15,750kg	0,01500
001 025 900200 00 00	W OTOMAT RAYI (DELİKLİ)(2m) FUSE BOX RAIL (SLOTTED) 2m	KUTU PACK	50	-	-

KABLO PABUÇLARI VE MUFLAR CABLE TERMINAL LUGS

EKO KABLO PABUÇLARI ECO TYPE CABLE TERMINAL LUGS

KOD CODE	AÇIKLAMA DESCRIPTION	CİVATA BOLT	D3 D3	D2 D2	D1 D1	L L	A A	ADET QUANTITY
123 037 000016	16-06 EKO TİP KABLO PABUCU/ 16-06 ECO TYPE CABLE TERMINAL LUGS	M6	6,5	5,8	7,4	30	12	500
123 037 000025	25-08 EKO TİP KABLO PABUCU/ 25-08 ECO TYPE CABLE TERMINAL LUGS	M8	8,5	7	9,2	40	14	350
123 037 000035	35-08 EKO TİP KABLO PABUCU/ 35-08 ECO TYPE CABLE TERMINAL LUGS	M8	8,5	8,2	10,7	44	15,3	200
123 037 000050	50-10 EKO TİP KABLO PABUCU/ 50-10 ECO TYPE CABLE TERMINAL LUGS	M10	10,5	10,2	12,8	52	20	150
123 037 000070	70-10 EKO TİP KABLO PABUCU/ 70-10 ECO TYPE CABLE TERMINAL LUGS	M10	10,5	11,7	14,7	55	22	100
123 037 000095	95-12 EKO TİP KABLO PABUCU/ 95-12 ECO TYPE CABLE TERMINAL LUGS	M12	13	13,6	16,7	59	26	70
123 037 000120	120-12 EKO TİP KABLO PABUCU/ 120-12 ECO TYPE CABLE TERMINAL LUGS	M12	13	15,5	19	70	29	50
123 037 000150	150-12 EKO TİP KABLO PABUCU/ 150-12 ECO TYPE CABLE TERMINAL LUGS	M12	13	16,7	21	77	32	40
123 037 000185	185-16 EKO TİP KABLO PABUCU/ 185-16 ECO TYPE CABLE TERMINAL LUGS	M16	17	18,8	23	85	35	30
123 037 000240	240-16 EKO TİP KABLO PABUCU/ 240-16 ECO TYPE CABLE TERMINAL LUGS	M16	17	21,2	26	90	38,5	24

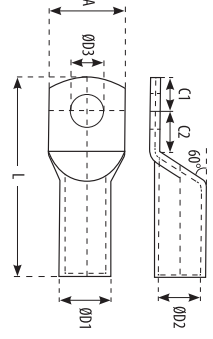

STANDART KABLO PABUÇLARI STANDARD TYPE CABLE TERMINAL LUGS

KOD CODE	AÇIKLAMA DESCRIPTION	CİVATA BOLT	D3 D3	D2 D2	D1 D1	L L	A A	ADET QUANTITY
123 037 500010	10-05 STANDART TİP KABLO PABUCU/STD. TYPE CABLE TERMINAL LUG	M5	5,2	5,8	7,4	30	12	500
123 037 500011	10-06 STANDART TİP KABLO PABUCU/STD. TYPE CABLE TERMINAL LUG	M6	6,5	7	9,2	40	14	350
123 037 500012	10-08 STANDART TİP KABLO PABUCU/STD. TYPE CABLE TERMINAL LUG	M8	8,5	8,2	10,7	44	15,3	200
123 037 500016	16-06 STANDART TİP KABLO PABUCU/STD. TYPE CABLE TERMINAL LUG	M6	6,5	10,2	12,8	52	20	150
123 037 500017	16-08 STANDART TİP KABLO PABUCU/STD. TYPE CABLE TERMINAL LUG	M8	8,5	11,7	14,7	55	22	100
123 037 500018	16-10 STANDART TİP KABLO PABUCU/STD. TYPE CABLE TERMINAL LUG	M10	10,5	13,6	16,7	59	26	70
123 037 500024	25-06 STANDART TİP KABLO PABUCU/STD. TYPE CABLE TERMINAL LUG	M6	6,5	15,5	19	70	29	50
123 037 500025	25-08 STANDART TİP KABLO PABUCU/STD. TYPE CABLE TERMINAL LUG	M8	8,5	16,7	21	77	32	40
123 037 500026	25-10 STANDART TİP KABLO PABUCU/STD. TYPE CABLE TERMINAL LUG	M10	10,5	18,8	23	85	35	30
123 037 500034	35-06 STANDART TİP KABLO PABUCU/STD. TYPE CABLE TERMINAL LUG	M6	6,5	21,2	26	90	38,5	24
123 037 500035	35-08 STANDART TİP KABLO PABUCU/STD. TYPE CABLE TERMINAL LUG	M8	8,5	5,8	7,4	30	12	500
123 037 500036	35-10 STANDART TİP KABLO PABUCU/STD. TYPE CABLE TERMINAL LUG	M10	10,5	7	9,2	40	14	350
123 037 500037	35-12 STANDART TİP KABLO PABUCU/STD. TYPE CABLE TERMINAL LUG	M12	13	8,2	10,7	44	15,3	200
123 037 500049	50-08 STANDART TİP KABLO PABUCU/STD. TYPE CABLE TERMINAL LUG	M8	8,5	10,2	12,8	52	20	150
123 037 500050	50-10 STANDART TİP KABLO PABUCU/STD. TYPE CABLE TERMINAL LUG	M10	10,5	11,7	14,7	55	22	100
123 037 500051	50-12 STANDART TİP KABLO PABUCU/STD. TYPE CABLE TERMINAL LUG	M12	13	13,6	16,7	59	26	70
123 037 500069	70-08 STANDART TİP KABLO PABUCU/STD. TYPE CABLE TERMINAL LUG	M8	8,5	15,5	19	70	29	50
123 037 500070	70-10 STANDART TİP KABLO PABUCU/STD. TYPE CABLE TERMINAL LUG	M10	10,5	16,7	21	77	32	40
123 037 500071	70-12 STANDART TİP KABLO PABUCU/STD. TYPE CABLE TERMINAL LUG	M12	10,5	18,8	23	85	35	30
123 037 500094	95-10 STANDART TİP KABLO PABUCU/STD. TYPE CABLE TERMINAL LUG	M10	13	21,2	26	90	38,5	24
123 037 500095	95-12 STANDART TİP KABLO PABUCU/STD. TYPE CABLE TERMINAL LUG	M12	10,5	5,8	7,4	30	12	500
123 037 500119	120-10 STANDART TİP KABLO PABUCU/STD. TYPE CABLE TERMINAL LUG	M10	13	7	9,2	40	14	350
123 037 500120	120-12 STANDART TİP KABLO PABUCU/STD. TYPE CABLE TERMINAL LUG	M12	10,5	8,2	10,7	44	15,3	200
123 037 500149	150-10 STANDART TİP KABLO PABUCU/STD. TYPE CABLE TERMINAL LUG	M10	13	10,2	12,8	52	20	150
123 037 500150	150-12 STANDART TİP KABLO PABUCU/STD. TYPE CABLE TERMINAL LUG	M12	10,5	11,7	14,7	55	22	100
123 037 500183	185-10 STANDART TİP KABLO PABUCU/STD. TYPE CABLE TERMINAL LUG	M10	13	13,6	16,7	59	26	70
123 037 500184	185-12 STANDART TİP KABLO PABUCU/STD. TYPE CABLE TERMINAL LUG	M12	17	15,5	19	70	29	50
123 037 500185	185-16 STANDART TİP KABLO PABUCU/STD. TYPE CABLE TERMINAL LUG	M16	10,5	16,7	21	77	32	40
123 037 500238	240-10 STANDART TİP KABLO PABUCU/STD. TYPE CABLE TERMINAL LUG	M10	13	18,8	23	85	35	30
123 037 500239	240-12 STANDART TİP KABLO PABUCU/STD. TYPE CABLE TERMINAL LUG	M12	17	21,2	26	90	38,5	24
123 037 500240	240-16 STANDART TİP KABLO PABUCU/STD. TYPE CABLE TERMINAL LUG	M16	13	16,7	21	77	32	40
123 037 500299	300-12 STANDART TİP KABLO PABUCU/STD. TYPE CABLE TERMINAL LUG	M12	17	18,8	23	85	35	30
123 037 500300	300-16 STANDART TİP KABLO PABUCU/STD. TYPE CABLE TERMINAL LUG	M16	17	21,2	26	90	38,5	24



BORU TİP SIKMALI EK MUFLAR COMPRESSION TYPE SPLICE CONNECTORS

KOD CODE	AÇIKLAMA DESCRIPTION	CİVATA BOLT	D3 D3	D2 D2	D1 D1	L L	A A	ADET QUANTITY
123 037 300016	16mm ² BORU TİP SIKMALI EK MUF/COMP. TYPE SPLICE CONNECTORS	M6	6,5	5,8	7,4	30	12	500
123 037 300025	25mm ² BORU TİP SIKMALI EK MUF/COMP. TYPE SPLICE CONNECTORS	M8	8,5	7	9,2	40	14	350
123 037 300035	35mm ² BORU TİP SIKMALI EK MUF/COMP. TYPE SPLICE CONNECTORS	M8	8,5	8,2	10,7	44	15,3	200
123 037 300050	50mm ² BORU TİP SIKMALI EK MUF/COMP. TYPE SPLICE CONNECTORS	M10	10,5	10,2	12,8	52	20	150
123 037 300070	70mm ² BORU TİP SIKMALI EK MUF/COMP. TYPE SPLICE CONNECTORS	M10	10,5	11,7	14,7	55	22	100
123 037 300095	95mm ² BORU TİP SIKMALI EK MUF/COMP. TYPE SPLICE CONNECTORS	M12	13	13,6	16,7	59	26	70
123 037 300120	120mm ² BORU TİP SIKMALI EK MUF/COMP. TYPE SPLICE CONNECTORS	M12	13	15,5	19	70	29	50
123 037 300150	150mm ² BORU TİP SIKMALI EK MUF/COMP. TYPE SPLICE CONNECTORS	M12	13	16,7	21	77	32	40
123 037 300185	185mm ² BORU TİP SIKMALI EK MUF/COMP. TYPE SPLICE CONNECTORS	M16	17	18,8	23	85	35	30
123 037 300240	240mm ² BORU TİP SIKMALI EK MUF/COMP. TYPE SPLICE CONNECTORS	M16	17	21,2	26	90	38,5	24





1983'ten beri...
Mutlusan[®]
electric

YENİ
NEW



CEE NORM

Profesyonel Çözümler
Professional Solutions

Sanayi Ürün Grubu
Industrial Product Group



SANAYİ FİŞ - PRİZ GRUBU (MONOFAZE 1X16A)

PLUG - SOCKET GROUP (MONOPHASE 1X16A)



CE
MUT-27

1x16A MONO. TOPRAKLI ERKEK FİŞ (EĞİK)
1x16A MONOPHASE EARTHED PLUG

Ürün Kodu	Product Code	010 083 300027
Ambalaj Şekli	Packing Type	Kutu - Pack
Adet	Quantity	40
Ağırlık	Weight	4,000 kg
Hacim	Volume	0,01673



CE
MUT-28

1x16A MONO. TOPRAKLI ERKEK FİŞ (DÜZ)
1x16A MONOPHASE EARTHED SOCKET

Ürün Kodu	Product Code	010 083 300028
Ambalaj Şekli	Packing Type	Kutu - Pack
Adet	Quantity	40
Ağırlık	Weight	4,125 kg
Hacim	Volume	0,01673



CE
MUT-29

1x16A MONO. TOPRAKLI DİŞİ FİŞ
1x16A MONOPHASE EARTHED SOCKET

Ürün Kodu	Product Code	010 083 300029
Ambalaj Şekli	Packing Type	Kutu - Pack
Adet	Quantity	25
Ağırlık	Weight	6,100 kg
Hacim	Volume	0,01673



CE
MUT-29/6

1x16A MONO. TOPRAKLI DUVAR PRİZİ
1x16A MONOPHASE EARTHED WALL SOCKET

Ürün Kodu	Product Code	010 083 500296
Ambalaj Şekli	Packing Type	Kutu - Pack
Adet	Quantity	20
Ağırlık	Weight	2,688 kg
Hacim	Volume	0,01673



CE
MUT-29/2

1x16A MONO. 2'Lİ GRUP PRİZ
1x16A MONOPHASE 2 GANG GROUP SOCKET

Ürün Kodu	Product Code	010 083 500292
Ambalaj Şekli	Packing Type	Kutu - Pack
Adet	Quantity	14
Ağırlık	Weight	3,300 kg
Hacim	Volume	0,01673



CE
MUT-29/3

1x16A MONO. 3'Lİ GRUP PRİZ
1x16A MONOPHASE 3 GANG GROUP SOCKET

Ürün Kodu	Product Code	010 083 500293
Ambalaj Şekli	Packing Type	Kutu - Pack
Adet	Quantity	12
Ağırlık	Weight	4,368 kg
Hacim	Volume	0,01673



CE
MUT-29/4

1x16A MONO. 4'Lİ GRUP PRİZ
1x16A MONOPHASE 4 GANG GROUP SOCKET

Ürün Kodu	Product Code	010 083 500294
Ambalaj Şekli	Packing Type	Kutu - pack
Adet	Quantity	10
Ağırlık	Weight	3,640 kg
Hacim	Volume	0,01673



CE
MUT-29/2A

1x16A MONO. 2'Lİ GRUP PRİZ ANAHTARLI
1x16A MONOPHASE 2 GANG GROUP SOCKET

Ürün Kodu	Product Code	010 083 501292
Ambalaj Şekli	Packing Type	Kutu - pack
Adet	Quantity	12
Ağırlık	Weight	3,888 kg
Hacim	Volume	0,01673



CE
MUT-29/3A

1x16A MONO. 3'Lİ GRUP PRİZ ANAHTARLI
1x16A MONOPHASE 3 GANG GROUP SOCKET WITH SWITCH

Ürün Kodu	Product Code	010 083 501293
Ambalaj Şekli	Packing Type	Kutu - pack
Adet	Quantity	10
Ağırlık	Weight	3,240 kg
Hacim	Volume	0,01673

SANAYİ PİŞ - PRİZ GRUBU (TRİFAZE 3X25A)

PLUG - SOCKET GROUP (THREE PHASE 3X25A)



CE
MUT-30

3x25A TRİFAZE ERKEK FİŞ
3x25A THREE PHASE WALL SOCKET

Ürün Kodu	Product Code	010 083 400030
Ambalaj Şekli	Packing Type	Kutu - pack
Adet	Quantity	25
Ağırlık	Weight	4,400 kg
Hacim	Volume	0,01673



CE
MUT-31

3x25A TRİFAZE DİŞİ FİŞ (SEYYAR)
3x25A THREE PHASE PORTABLE SOCKET

Ürün Kodu	Product Code	010 083 400031
Ambalaj Şekli	Packing Type	Kutu - pack
Adet	Quantity	20
Ağırlık	Weight	3,480 kg
Hacim	Volume	0,01673



CE
MUT-31/5

3x25A TRİFAZE DUVAR PRİZİ
3x25A THREE PHASE WALL SOCKET

Ürün Kodu	Product Code	010 083 600315
Ambalaj Şekli	Packing Type	Kutu - pack
Adet	Quantity	20
Ağırlık	Weight	4,140 kg
Hacim	Volume	0,01673

SANAYİ FİŞ - PRİZ GRUBU (TRİFAZE) PLUG - SOCKET GROUP (THREE PHASE)



MUT-31/1

1 TRİFAZE + 1 MONOFAZE GR. PRİZ

1 THREE PHASE + 1 MONOFAZE GROUP SOCKET

Ürün Kodu	Product Code	010 083 600311
Ambalaj Şekli	Packing Type	Kutu - pack
Adet	Quantity	10
Ağırlık	Weight	4,670 kg
Hacim	Volume	0,01673



MUT-31/2

TRİFAZE GRUP PRİZ -2'Lİ

THREE PHASE 2 GANG GROUP SOCKET

Ürün Kodu	Product Code	010 083 600312
Ambalaj Şekli	Packing Type	Kutu - pack
Adet	Quantity	10
Ağırlık	Weight	4,670 kg
Hacim	Volume	0,01673



MUT-31/3

TRİFAZE GRUP PRİZ 3'LÜ GRUP PRİZ

THREE PHASE 3 GANG GROUP SOCKET

Ürün Kodu	Product Code	010 083 600313
Ambalaj Şekli	Packing Type	Kutu - pack
Adet	Quantity	10
Ağırlık	Weight	5,750 kg
Hacim	Volume	0,01673



MUT-31/6

2 TRİFAZE + 1 MONOFAZE GR.PRİZ

2 THREE PHASE + 1 MON. PHASE GROUP SOCKET

Ürün Kodu	Product Code	010 083 600316
Ambalaj Şekli	Packing Type	Kutu - pack
Adet	Quantity	10
Ağırlık	Weight	5,390 kg
Hacim	Volume	0,01673



MUT-31/7

1 TRİFAZE + 2 MONOFAZE GR. PRİZ

1 THREE PHASE + 2 MON.PHASE GROUP SOCKET

Ürün Kodu	Product Code	010 083 600317
Ambalaj Şekli	Packing Type	Kutu - pack
Adet	Quantity	10
Ağırlık	Weight	5,740 kg
Hacim	Volume	0,01673

"Sanayide Gücünüzü
Sağlam Bağlantılarla
Artırın!"
PLUG - SOCKET GROU
(THREE PHASE)

SANAYİ FİŞ - PRİZ GRUBU (TRİFAZE 3X16A) PLUG - SOCKET GROUP (THREE PHASE 3X16A)



MUT-60

3x16A TRİFAZE ERKEK FİŞ

3X16A THREE PHASE EARTHED PLUG

Ürün Kodu	Product Code	010 083 400060
Ambalaj Şekli	Packing Type	Kutu - pack
Adet	Quantity	30
Ağırlık	Weight	4,650 kg
Hacim	Volume	0,01673



MUT-61

3x16A TRİFAZE SEYYAR DIŞI FİŞ

3X16A THREE PHASE SOCKET

Ürün Kodu	Product Code	010 083 400061
Ambalaj Şekli	Packing Type	Kutu - pack
Adet	Quantity	24
Ağırlık	Weight	4,825 kg
Hacim	Volume	0,01673



MUT-62

3x16A TRİFAZE DUVAR PRİZİ

1X16A MONOPHASE EARTHED PLUG

Ürün Kodu	Product Code	010 083 400062
Ambalaj Şekli	Packing Type	Kutu - pack
Adet	Quantity	20
Ağırlık	Weight	4,900 kg
Hacim	Volume	0,01673

SANAYİ FİŞ - PRİZ GRUBU (TRİFAZE 3X32A) PLUG - SOCKET GROUP (THREE PHASE 3X32A)



MUT-70

3x32A TRİFAZE ERKEK FİŞ

3X32A THREE PHASE EARTHED PLUG

Ürün Kodu	Product Code	010 083 400070
Ambalaj Şekli	Packing Type	Kutu - pack
Adet	Quantity	20
Ağırlık	Weight	4,400 kg
Hacim	Volume	0,01673



MUT-71

3x32A TRİFAZE SEYYAR DIŞI FİŞ

3X32A THREE PHASE SOCKET

Ürün Kodu	Product Code	010 083 400071
Ambalaj Şekli	Packing Type	Kutu - pack
Adet	Quantity	15
Ağırlık	Weight	3,480 kg
Hacim	Volume	0,01673



MUT-72

3x32A TRİFAZE DUVAR PRİZİ

3X32A MONOPHASE EARTHED PLUG

Ürün Kodu	Product Code	010 083 400072
Ambalaj Şekli	Packing Type	Kutu - pack
Adet	Quantity	20
Ağırlık	Weight	6,100 kg
Hacim	Volume	0,01673

MUTLUSAN CEE NORM SANAYİ TİPİ FİŞ - PRİZ GRUBU

MUTLUSAN CEE NORM PLUG - SOCKET GROUP

YENİ
NEW



CE

MUT-301
3/16A DÜZ FİŞ
3/16A FLAT PLUG

MUT-310
3/32A DÜZ FİŞ
3/32A FLAT PLUG

Ürün Kodu	Product Code	010 083 000316	010 083 000332
Ambalaj Şekli	Packing Type	Kutu - Pack	Kutu - Pack
Adet	Quantity	16	12
Ağırlık	Weight	- kg	- kg
Hacim	Volume	-	-



CE

MUT-302
3/16 UZATMA PRİZ
3/16 EXTENSION PLUG

MUT-320
3/32 UZATMA PRİZ
3/32 EXTENSION PLUG

Ürün Kodu	Product Code	010 083 010316	010 083 010332
Ambalaj Şekli	Packing Type	Kutu - Pack	Kutu - Pack
Adet	Quantity	15	12
Ağırlık	Weight	- kg	- kg
Hacim	Volume	-	-



CE

MUT-303
3/16 MAKİNE PRİZİ
3/16 MACHINE SOCKET

MUT-330
3/32 MAKİNE PRİZİ
3/32 MACHINE SOCKET

Ürün Kodu	Product Code	010 083 020316	010 083 020332
Ambalaj Şekli	Packing Type	Kutu - Pack	Kutu - Pack
Adet	Quantity	20	14
Ağırlık	Weight	- kg	- kg
Hacim	Volume	-	-



CE

MUT-304
3/16 DUVAR PRİZİ
3/16 WALL PLUG

MUT-340
3/32 DUVAR PRİZİ
3/32 WALL PLUG

Ürün Kodu	Product Code	010 083 030316	010 083 030332
Ambalaj Şekli	Packing Type	Kutu - Pack	Kutu - Pack
Adet	Quantity	8	8
Ağırlık	Weight	- kg	- kg
Hacim	Volume	-	-



CE

MUT-401
4/16A DÜZ FİŞ
4/16A FLAT PLUG

MUT-410
4/32A DÜZ FİŞ
4/32A FLAT PLUG

Ürün Kodu	Product Code	010 083 000416	010 083 000432
Ambalaj Şekli	Packing Type	Kutu - Pack	Kutu - Pack
Adet	Quantity	16	14
Ağırlık	Weight	- kg	- kg
Hacim	Volume	-	-



CE

MUT-402
4/16A UZATMA PRİZ
4/16A EXTENSION PLUG

MUT-420
4/32A UZATMA PRİZ
4/32A EXTENSION PLUG

Ürün Kodu	Product Code	010 083 010416	010 083 010432
Ambalaj Şekli	Packing Type	Kutu - Pack	Kutu - Pack
Adet	Quantity	15	12
Ağırlık	Weight	- kg	- kg
Hacim	Volume	-	-



CE

MUT-403
4/16A MAKİNE PRİZİ
4/16A MACHINE PLUG

MUT-430
4/32 A MAKİNE PRİZİ
4/32A MACHINE PLUG

Ürün Kodu	Product Code	010 083 020416	010 083 020432
Ambalaj Şekli	Packing Type	Kutu - Pack	Kutu - Pack
Adet	Quantity	20	14
Ağırlık	Weight	- kg	- kg
Hacim	Volume	-	-



CE

MUT-404
4/16A DUVAR PRİZİ
4/16A WALL PLUG

MUT-440
4/32A DUVAR PRİZ
4/32A WALL PLUG

Ürün Kodu	Product Code	010 083 030416	010 083 030432
Ambalaj Şekli	Packing Type	Kutu - Pack	Kutu - Pack
Adet	Quantity	8	8
Ağırlık	Weight	- kg	- kg
Hacim	Volume	-	-



CE

MUT-101
5x16A DÜZ FİŞ
5x16A FLAT PLUG

MUT-201
5x32A DÜZ FİŞ
5x32A FLAT PLUG

Ürün Kodu	Product Code	010 083 000516	010 083 000532
Ambalaj Şekli	Packing Type	Kutu - Pack	Kutu - Pack
Adet	Quantity	16	14
Ağırlık	Weight	2,530 kg	4,010 kg
Hacim	Volume	0,0133	0,0133



CE

MUT-103
5x16A MAKİNE PRİZİ
5x16A MACHINE SOCKET

MUT-203
5x32A MAKİNE PRİZİ
5x32A MACHINE SOCKET

Ürün Kodu	Product Code	010 083 020516	010 083 020532
Ambalaj Şekli	Packing Type	Kutu - Pack	Kutu - Pack
Adet	Quantity	20	14
Ağırlık	Weight	4,030 kg	3,880 kg
Hacim	Volume	0,0133	0,0133



CE

MUT-102
5x16A UZATMA PRİZİ
5x16A EXTENSION PLUG

MUT-202
5x32A UZATMA PRİZİ
5x32A EXTENSION PLUG

Ürün Kodu	Product Code	010 083 010516	010 083 010532
Ambalaj Şekli	Packing Type	Kutu - Pack	Kutu - Pack
Adet	Quantity	15	12
Ağırlık	Weight	3,190 kg	3,750 kg
Hacim	Volume	0,0133	0,0133



CE

MUT-104
5x16A DUVAR PRİZİ
5x16A WALL PLUG

MUT-204
5x32A DUVAR PRİZİ
5x32A WALL PLUG

Ürün Kodu	Product Code	010 083 030516	010 083 030532
Ambalaj Şekli	Packing Type	Kutu - Pack	Kutu - Pack
Adet	Quantity	8	8
Ağırlık	Weight	2,100 kg	2,590 kg
Hacim	Volume	0,0133	0,0133

MUTLUSAN SANAYİ TİPİ FİŞ - PRİZ GRUBU (MONOFAZE 1x16A)

MUTLUSAN PLUG - SOCKET GROUP (MON.PHASE 1x16A)

YENİ
NEW



CE

MUT-29/8
MONOFAZE TOP. PANO PRİZİ
MONO PHASE EARTHED PANEL SOCKET

Ürün Kodu	Product Code	010 083 500298
Ambalaj Şekli	Packing Type	Kutu - Pack
Adet	Quantity	40
Ağırlık	Weight	1,954 kg
Hacim	Volume	0,01673



CE

MUT-29/9
MONOFAZE MAKİNE PRİZİ
MONO PHASE MACHINE PLUG

Ürün Kodu	Product Code	010 083 500299
Ambalaj Şekli	Packing Type	Kutu - Pack
Adet	Quantity	20
Ağırlık	Weight	2,564 kg
Hacim	Volume	0,01673



CE

MUT-29/10
MONOFAZE DUVAR PRİZİ
MONO.PHASE WALL PLUG

Ürün Kodu	Product Code	010 083 502910
Ambalaj Şekli	Packing Type	Kutu - Pack
Adet	Quantity	15
Ağırlık	Weight	2,723 kg
Hacim	Volume	0,01673



CE

MUT-29/7
MONOFAZE DUVAR PRİZİ
MONO.PHASE WALL PLUG

Ürün Kodu	Product Code	010 083 500297
Ambalaj Şekli	Packing Type	Kutu - Pack
Adet	Quantity	30
Ağırlık	Weight	2,394 kg
Hacim	Volume	0,01673

SANAYİ PİŞ - PRİZ GRUBU (TRİFAZE)

PLUG - SOCKET GROUP (THREE PHASE)



CE

	MUT-64 3x16 TRİFAZE MAKİNE PRİZİ THREE PHASE AUTOMACHINE SOCKET	MUT-31/8 3x25 TRİFAZE MAKİNE PRİZİ THREE PHASE AUTOMACHINE SOCKET	MUT-74 3x32 TRİFAZE MAKİNE PRİZİ THREE PHASE AUTOMACHINE SOCKET	
Ürün Kodu	Product Code	010 083 400064	010 083 400318	010 083 400074
Ambalaj Şekli	Packing Type	Kutu - Pack	Kutu - Pack	Kutu - Pack
Adet	Quantity	20	20	20
Ağırlık	Weight	3,000 kg	2,530 kg	3,200 kg
Hacim	Volume	0,01673	0,01673	0,01673



CE

	MUT-63 1x16 TRİFAZE DUVAR PRİZİ THREE PHASE WALL SOCKET	MUT-31/9 3x25 TRİFAZE DUVAR PRİZİ THREE PHASE WALL SOCKET	MUT-73 3x32 TRİFAZE DUVAR PRİZİ THREE PHASE WALL SOCKET	
Ürün Kodu	Product Code	010 083 400063	010 083 400319	010 083 400073
Ambalaj Şekli	Packing Type	Kutu - Pack	Kutu - Pack	Kutu - Pack
Adet	Quantity	12	15	12
Ağırlık	Weight	2,460 kg	2,730 kg	2,587 kg
Hacim	Volume	0,01673	0,01673	0,01673



TERMOPLASTİK BUATLAR

THERMOPLASTIC JUNCTION BOXES

KOMBİNASYON PANOLAR

COMBINATION BOARDS



TERMOPLASTİK BUATLAR

THERMOPLASTIC JUNCTION BOXES



001 046 090090 00 17 ALEV YAYMAYAN
NON FLAMMABLE
001 046 070090 00 17 ALEV YAYAN
FLAMMABLE

Ø 90 TERMOPLASTİK BUAT
Ø 90 THERMOPLASTIC JUNCTION BOX

Ambalaj Şekli	Packing Type	Kutu - Box
Adet	Quantity	108
Ağırlık	Weight	7,647 kg
m ³	Volume	0,06858



001 046 098585 00 17 ALEV YAYMAYAN
NON FLAMMABLE
001 046 078585 00 17 ALEV YAYAN
FLAMMABLE

Ø 85x85x48 TERMOPLASTİK BUAT
Ø 85x85x48 THERMOPLASTIC JUNCTION BOX

Ambalaj Şekli	Packing Type	Kutu - Box
Adet	Quantity	108
Ağırlık	Weight	9,288 kg
m ³	Volume	0,06480



001 046 098080 00 17 ALEV YAYMAYAN
NON FLAMMABLE
001 046 078080 00 17 ALEV YAYAN
FLAMMABLE

Ø 80x80x48 TERMOPLASTİK 7 ÇIKIŞLI BUAT
Ø 80x80x48 THERMOPLASTIC JUNCTION BOX WITH
7 OUTLETS

Ambalaj Şekli	Packing Type	Kutu - Box
Adet	Quantity	108
Ağırlık	Weight	9,025 kg
m ³	Volume	0,06858



001 046 098080 00 17 ALEV YAYMAYAN
NON FLAMMABLE
001 046 078080 00 17 ALEV YAYAN
FLAMMABLE

Ø 110x110x74 TERMOPLASTİK 8 ÇIKIŞLI BUAT
Ø 110x110x74 THERMOPLASTIC JUNCTION BOX WITH
8 OUTLETS

Ambalaj Şekli	Packing Type	Kutu - Box
Adet	Quantity	40
Ağırlık	Weight	9,708 kg
m ³	Volume	0,04840



001 046 091118 00 17 ALEV YAYMAYAN
NON FLAMMABLE
001 046 071118 00 17 ALEV YAYAN
FLAMMABLE

Ø 110x180x77 TERMOPLASTİK 10 ÇIKIŞLI BUAT
Ø 110x180x77 THERMOPLASTIC JUNCTION BOX WITH
10 OUTLETS

Ambalaj Şekli	Packing Type	Kutu - Box
Adet	Quantity	30
Ağırlık	Weight	10,908 kg
m ³	Volume	0,05850



001 046 091827 00 17 ALEV YAYMAYAN
NON FLAMMABLE
001 046 071827 00 17 ALEV YAYAN
FLAMMABLE

Ø 180x270x100 TERMOPLASTİK 14 ÇIKIŞLI BUAT
Ø 180x270x100 THERMOPLASTIC JUNCTION BOX WITH
14 OUTLETS

Ambalaj Şekli	Packing Type	Kutu - Box
Adet	Quantity	8
Ağırlık	Weight	6,907 kg
m ³	Volume	0,04728



001 046 092698 00 44 ALEV YAYMAYAN
NON FLAMMABLE
001 046 072698 00 44 ALEV YAYAN
FLAMMABLE

Ø 138x226x98 ŞEFFAF TERMOPLASTİK BUAT
Ø 138x226x98 TRANSPARENT THERMOPLASTIC JUNCTION
BOXES

Ambalaj Şekli	Packing Type	Kutu - Box
Adet	Quantity	8
Ağırlık	Weight	4,110 kg
m ³	Volume	0,03671



001 046 096131 00 44 ALEV YAYMAYAN
NON FLAMMABLE
001 046 076131 00 44 ALEV YAYAN
FLAMMABLE

Ø 138x226x131 TERMOPLASTİK BUAT
Ø 138x226x131 TRANSPARENT THERMOPLASTIC JUNCTION
BOXES

Ambalaj Şekli	Packing Type	Kutu - Box
Adet	Quantity	8
Ağırlık	Weight	4,565 kg
m ³	Volume	0,04010

TERMOPLASTİK BUATLAR

THERMOPLASTIC JUNCTION BOXES



001 046 091199 00 44  ALEV YAYMAYAN
NON FLAMMABLE
001 046 071199 00 44 ALEV YAYAN
FLAMMABLE

Ø 225x311x99 ŞEFFAF TERMOPLASTİK BUAT
Ø 225x311x99 TRANSPARENT THERMOPLASTIC JUNCTION
BOXES

Ambalaj Şekli	Packing Type	Kutu - Box
Adet	Quantity	4
Ağırlık	Weight	3,500 kg
m ³	Volume	0,03238



001 046 091130 00 44  ALEV YAYMAYAN
NON FLAMMABLE
001 046 071130 00 44 ALEV YAYAN
FLAMMABLE

Ø 225x311x130 ŞEFFAF TERMOPLASTİK BUAT
Ø 225x311x130 TRANSPARENT THERMOPLASTIC JUNCTION
BOXES

Ambalaj Şekli	Packing Type	Kutu - Box
Adet	Quantity	4
Ağırlık	Weight	4,100 kg
m ³	Volume	0,04010



001 046 092698 00 17  ALEV YAYMAYAN
NON FLAMMABLE
001 046 072698 00 17 ALEV YAYAN
FLAMMABLE

Ø 138x226x98 TERMOPLASTİK BUAT
Ø 138x226x98 THERMOPLASTIC BOXES

Ambalaj Şekli	Packing Type	Kutu - Box
Adet	Quantity	8
Ağırlık	Weight	3,945 kg
m ³	Volume	0,02668



001 046 096131 00 17  ALEV YAYMAYAN
NON FLAMMABLE
001 046 076131 00 17 ALEV YAYAN
FLAMMABLE

Ø 138x226x131 TERMOPLASTİK BUAT
Ø 138x226x131 THERMOPLASTIC BOXES

Ambalaj Şekli	Packing Type	Kutu - Box
Adet	Quantity	8
Ağırlık	Weight	4,400 kg
m ³	Volume	0,03694



001 046 091199 00 17  ALEV YAYMAYAN
NON FLAMMABLE
001 046 071199 00 17 ALEV YAYAN
FLAMMABLE

Ø 225x311x99 TERMOPLASTİK BUAT
Ø 225x311x99 THERMOPLASTIC BOXES

Ambalaj Şekli	Packing Type	Kutu - Box
Adet	Quantity	4
Ağırlık	Weight	3,375 kg
m ³	Volume	0,03238



001 046 091130 00 17  ALEV YAYMAYAN
NON FLAMMABLE
001 046 071130 00 17 ALEV YAYAN
FLAMMABLE

Ø 225x311x130 TERMOPLASTİK BUAT
Ø 225x311x130 THERMOPLASTIC BOXES

Ambalaj Şekli	Packing Type	Kutu - Box
Adet	Quantity	4
Ağırlık	Weight	3,895 kg
m ³	Volume	0,03974



001 046 098226 00 17  ALEV YAYMAYAN
NON FLAMMABLE
001 046 078226 00 17 ALEV YAYAN
FLAMMABLE

Ø 138x226x127 KOMBİNASYON KUTUSU
Ø 138x226x127 COMBINATION BOX

Ambalaj Şekli	Packing Type	Kutu - Box
Adet	Quantity	8
Ağırlık	Weight	5,025 kg
m ³	Volume	0,03694



001 046 095311 00 17  ALEV YAYMAYAN
NON FLAMMABLE
001 046 075311 00 17 ALEV YAYAN
FLAMMABLE

Ø 225x311x132 KOMBİNASYON KUTUSU
Ø 225x311x132 COMBINATION BOX

Ambalaj Şekli	Packing Type	Kutu - Box
Adet	Quantity	4
Ağırlık	Weight	4,210 kg
m ³	Volume	0,04010

KOMBİNASYON PANOLARI COMBINATION BOARDS



010 104 000180

MK-325-2
3x25 A 1 ADET ÖN + 1x16 A 2 ADET YAN

MK-325-2
3/25 A. 380V. 1 PCS. FRONT - 1/16 A. 220V. 2 PCS. SIDE

Ambalaj Şekli	Packing Type	Kutu - Box
Adet	Quantity	4
Ağırlık	Weight	3,540 kg
m ³	Volume	0,0353



010 104 000181

MK-516-1
5x16 A 1 ADET ÖN + 1x16 A 1 ADET YAN

MK-516-1
5/16 A. 380V. 1 PCS. FRONT - 1/16 A. 220V. 1 PCS. SIDE

Ambalaj Şekli	Packing Type	Kutu - Box
Adet	Quantity	6
Ağırlık	Weight	-
m ³	Volume	-



010 104 000182

MK-516-2
5x16 A 1 ADET ÖN + 1x16 A 2 ADET YAN

MK-516-2
5/16 A. 380V. 1 PCS. FRONT - 1/16 A. 220V. 2 PCS. SIDE

Ambalaj Şekli	Packing Type	Kutu - Box
Adet	Quantity	4
Ağırlık	Weight	3,750 kg
m ³	Volume	0,0351



010 104 000183

MK-532-1
5x32 A 1 ADET ÖN + 1x16 A 1 ADET YAN

MK-532-1
5/32 A. 380V. 1 PCS. FRONT - 1/16 A. 220V. 1 PCS. SIDE

Ambalaj Şekli	Packing Type	Kutu - Box
Adet	Quantity	4
Ağırlık	Weight	-
m ³	Volume	-



010 104 000184

MK-532-2
5x32 A 1 ADET ÖN + 1x16 A 2 ADET YAN

MK-532-2
5/32 A. 380V. 1 PCS. FRONT - 1/16 A. 220V. 2 PCS. SIDE

Ambalaj Şekli	Packing Type	Kutu - Box
Adet	Quantity	4
Ağırlık	Weight	3,950 kg
m ³	Volume	0,0362



010 104 000185

MK-2325-2
3x25 A 2 ADET ÖN + 1x16 A 2 ADET YAN

MK-2325-2
3/25 A. 380V. 2 PCS. FRONT - 1/16 A. 220V. 2 PCS. SIDE

Ambalaj Şekli	Packing Type	Kutu - Box
Adet	Quantity	4
Ağırlık	Weight	-
m ³	Volume	-



010 104 000186

MK-2516-2
5x16 A 2 ADET ÖN + 1x16 A 2 ADET YAN

MK-2516-2
5/16 A. 380V. 2 PCS. FRONT - 1/16 A. 220V. 2 PCS. SIDE

Ambalaj Şekli	Packing Type	Kutu - Box
Adet	Quantity	4
Ağırlık	Weight	5,960 kg
m ³	Volume	0,0606



010 104 000187

MK-2516-4
5x16 A 2 ADET ÖN + 1x16 A 4 ADET YAN

MK-2516-4
5/16 A. 380V. 2 PCS. FRONT - 1/16 A. 220V. 4 PCS. SIDE

Ambalaj Şekli	Packing Type	Kutu - Box
Adet	Quantity	4
Ağırlık	Weight	6,560 kg
m ³	Volume	0,0591



010 104 000188

MK-2532-2
5x32 A 2 ADET ÖN + 1x16 A 2 ADET YAN

MK-2532-2
5/32 A. 380V. 2 PCS. FRONT - 1/16 A. 220V. 2 PCS. SIDE

Ambalaj Şekli	Packing Type	Kutu - Box
Adet	Quantity	4
Ağırlık	Weight	6,550 kg
m ³	Volume	0,0585



010 104 000189

MK-2532-4
5x32 A 2 ADET ÖN + 1x16 A 4 ADET YAN

MK-516-1
5/16 A. 380V. 1 PCS. FRONT - 1/16 A. 220V. 4 PCS. SIDE

Ambalaj Şekli	Packing Type	Kutu - Box
Adet	Quantity	4
Ağırlık	Weight	-
m ³	Volume	-



010 104 000190

MK-5164-4
5x16 A 4 ADET ÖN + 1x16 A 4 ADET YAN

MK-516-2
5/16 A. 380V. 4 PCS. FRONT - 1/16 A. 220V. 4 PCS. SIDE

Ambalaj Şekli	Packing Type	Kutu - Box
Adet	Quantity	3
Ağırlık	Weight	-
m ³	Volume	-



010 104 000191

MK-5324-4
5x32 A 4 ADET ÖN + 1x16 A 4 ADET YAN

MK-5324-4
5/32 A. 380V. 4 PCS. FRONT - 1/16 A. 220V. 4 PCS. SIDE

Ambalaj Şekli	Packing Type	Kutu - Box
Adet	Quantity	3
Ağırlık	Weight	-
m ³	Volume	-



010 104 000192

MK-51632-4
5x16 A 2 ADET ÖN + 5x32 A 2 ADET ÖN + 1x16 A 4 ADET YAN

MK-51632-4
5/16 A. 380V. 2 PCS. FRONT - 5/32 A. 380V. 2 PCS. FRONT
1/16 A. 220V. 4 PCS. SIDE

Ambalaj Şekli	Packing Type	Kutu - Box
Adet	Quantity	3
Ağırlık	Weight	-
m ³	Volume	-



010 046 075130 00 17

1'LI KOMBİNASYON KUTUSU BOŞ 215x130 GRİ

SOCKET DISTRIBUTION BOX (EMPTY) (215x130)

Ambalaj Şekli	Packing Type	Kutu - Box
Adet	Quantity	10
Ağırlık	Weight	-
m ³	Volume	-



010 046 070220 00 17

2'LI KOMBİNASYON KUTUSU BOŞ 290x220 GRİ

SOCKET DISTRIBUTION BOX (EMPTY) (290x220)

Ambalaj Şekli	Packing Type	Kutu - Box
Adet	Quantity	4
Ağırlık	Weight	-
m ³	Volume	-



Profesyonel Çözümler
Professional Solutions



Sinyal ve Kumanda Butonları
Signal and Control Buttons



SWISS SERİSİ SİNYAL BUTONLARI

SWISS SIGNAL AND CONTROL BUTTONS



10 MM SİNYAL ARMATÜRÜ
10 MM SIGNAL LUMINAIRE
Silikon Kablolu / Silicon Cable

Ürün Kodu	Product Code	010 090 010001
Ambalaj Şekli	Packing Type	Kutu - Pack
Adet	Quantity	100
Ağırlık	Weight	400,07 gr
Hacim	Volume	0,0017



14 MM SİNYAL ARMATÜRÜ
14 MM SIGNAL LUMINAIRE

Ürün Kodu	Product Code	010 090 010005 (12V Neon Lamp) 010 090 010006 (24V) 010 090 010007 (220V)
Ambalaj Şekli	Packing Type	Kutu - Pack
Adet	Quantity	50
Ağırlık	Weight	250,07 gr
Hacim	Volume	0,0017



22 MM SİNYAL ARMATÜRÜ
22 MM SIGNAL LUMINAIRE

Ürün Kodu	Product Code	010 090 010008 (12V Neon Lamp) 010 090 010009 (24V) 010 090 010010 (220V)
Ambalaj Şekli	Packing Type	Kutu - Pack
Adet	Quantity	24
Ağırlık	Weight	348,07 gr
Hacim	Volume	0,0017



Ba9s LEDLİ IŞIK SOKETLİ ADAPTÖRLÜ
22mm 220V SİNYAL ARMATÜRÜ
22mm Ba9s SIGNAL LUMINAIRE
WITH LAMP BASE, LED LIGHT SOCKET 220V

Ürün Kodu	Product Code	010 090 010004
Ambalaj Şekli	Packing Type	Kutu - Pack
Adet	Quantity	24
Ağırlık	Weight	432,07 gr
Hacim	Volume	0,0017



LED'Lİ BUZZER / BUZZER
BUZZER WITH LED / BUZZER

Ürün Kodu	Product Code	010 111 070002(24V) 010 111 070001(220V)
Ürün Kodu	Product Code	010 111 070004(24V) 010 111 070003(220V)
Ambalaj Şekli	Packing Type	Kutu - Pack
Adet	Quantity	24
Ağırlık	Weight	444,07 gr
Hacim	Volume	0,0017



SW-AA42
22mm PLASTİK YAYLI BUTON-STOP
22mm PUSH BUTTON / OFF-1NC

Ürün Kodu	Product Code	010 104 000003
Ambalaj Şekli	Packing Type	Kutu - Pack
Adet	Quantity	10
Ağırlık	Weight	284,5 gr
Hacim	Volume	0,0009

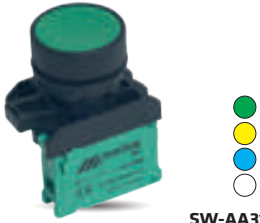

SW-AA31
22mm PLASTİK YAYLI BUTON / START
22mm PUSH BUTTON / ON-1NO

Ürün Kodu	Product Code	010 104 000004
Ambalaj Şekli	Packing Type	Kutu - Pack
Adet	Quantity	10
Ağırlık	Weight	284,5 gr
Hacim	Volume	0,0009



SW-AA322
22mm PLASTİK YAYLI BUTON / STOP-1NC
22mm PUSH BUTTON / STOP-1NC

Ürün Kodu	Product Code	010 104 000009
Ambalaj Şekli	Packing Type	Kutu - Pack
Adet	Quantity	10
Ağırlık	Weight	240 gr
Hacim	Volume	0,0009



SW-AA3361
22mm PLASTİK YAYLI BUTON / START-1NO
22mm PLUSH BUTTON / START-1NO

Ürün Kodu	Product Code	010 104 000010
Ambalaj Şekli	Packing Type	Kutu - Pack
Adet	Quantity	10
Ağırlık	Weight	240 gr
Hacim	Volume	0,0009



SW-AA3351
22mm PLASTİK YAYLI BUTON / START
22mm PLUSH BUTTON / START-1NO

Ürün Kodu	Product Code	010 104 000011
Ambalaj Şekli	Packing Type	Kutu - Pack
Adet	Quantity	10
Ağırlık	Weight	240 gr
Hacim	Volume	0,0009



SW-AA3341
22mm PLASTİK YAYLI BUTON / START
22mm PLUSH BUTTON / START-1NO

Ürün Kodu	Product Code	010 104 000012
Ambalaj Şekli	Packing Type	Kutu - Pack
Adet	Quantity	10
Ağırlık	Weight	240 gr
Hacim	Volume	0,0009



SW-AA3371
22mm PLASTİK YAYLI BUTON / START
22mm PLUSH BUTTON / START-1NO

Ürün Kodu	Product Code	010 104 000013
Ambalaj Şekli	Packing Type	Kutu - Pack
Adet	Quantity	10
Ağırlık	Weight	240 gr
Hacim	Volume	0,0009

SWISS SERİSİ SİNYAL BUTONLARI

SWISS SIGNAL AND CONTROL BUTTONS



SW-AA3381
22mm PLASTİK YAYLI BUTON/START-1NO
22mm PLUSH BUTTON

Ürün Kodu	Product Code	010 104 000014
Ambalaj Şekli	Packing Type	Kutu - Pack
Adet	Quantity	10
Ağırlık	Weight	240 gr
Hacim	Volume	0,0009



SW-AL7325
22mm PLASTİK İKİZ BUTON/1NO+1NC
22mm LED DOUBLE PUSH BUTTON

Ürün Kodu	Product Code	010 104 000015
Ambalaj Şekli	Packing Type	Kutu - Pack
Adet	Quantity	10
Ağırlık	Weight	466,5 gr
Hacim	Volume	0,0017



SW-AL7181
22mm PLASTİK ALARM LAMBA
İKİZ BUTON/1NO+1NO
22mm LED DOUBLE PUSH BUTTON

Ürün Kodu	Product Code	010 104 000016
Ambalaj Şekli	Packing Type	Kutu - Pack
Adet	Quantity	10
Ağırlık	Weight	166,5 gr
Hacim	Volume	0,0017



SW-AL4252
22mm PLASTİK YUKARI AŞAĞI OKLU
TERS YÖNLÜ İKİZ BUTON / 1NO+1NO
22mm LED DOUBLE PUSH BUTTON

Ürün Kodu	Product Code	010 104 000017
Ambalaj Şekli	Packing Type	Kutu - Pack
Adet	Quantity	10
Ağırlık	Weight	466,5 gr
Hacim	Volume	0,0017



SW-AL6171
22mm PLASTİK ALARM ORTAK OKLU
İKİZ BUTON / 1NO+1NO
22mm LED DOUBLE PUSH BUTTON

Ürün Kodu	Product Code	010 104 000018
Ambalaj Şekli	Packing Type	Kutu - Pack
Adet	Quantity	10
Ağırlık	Weight	466,5 gr
Hacim	Volume	0,0017



SW-AL6181
22mm PLASTİK LAMBA ORTAK OKLU
İKİZ BUTON / 1NO+1NO
22mm LED DOUBLE PUSH BUTTON

Ürün Kodu	Product Code	010 104 000019
Ambalaj Şekli	Packing Type	Kutu - Pack
Adet	Quantity	10
Ağırlık	Weight	466,5 gr
Hacim	Volume	0,0017



SW-AL7425
22mm PLASTİK İŞARETLİ İKİZ BUTON / 1NO+1NC
22mm LED DOUBLE PUSH BUTTON

Ürün Kodu	Product Code	010 104 000020
Ambalaj Şekli	Packing Type	Kutu - Pack
Adet	Quantity	10
Ağırlık	Weight	466,5 gr
Hacim	Volume	0,0017



SW-AL7525
22mm PLASTİK YAZILI BUTON / 1NO+1NC
22mm LED DOUBLE PUSH BUTTON

Ürün Kodu	Product Code	010 104 000021
Ambalaj Şekli	Packing Type	Kutu - Pack
Adet	Quantity	10
Ağırlık	Weight	466,5 gr
Hacim	Volume	0,0017



SW-AL4151
22mm PLASTİK YUKARI AŞAĞI
OKLU BUTON / 1NO+1NO
22mm LED DOUBLE PUSH BUTTON

Ürün Kodu	Product Code	010 104 000022
Ambalaj Şekli	Packing Type	Kutu - Pack
Adet	Quantity	10
Ağırlık	Weight	466,5 gr
Hacim	Volume	0,0017



SW-AL7465L
22mm PLASTİK İKİZ BUTON LEDLİ
(220V AC/DC) / 1NO+1NO
22mm LED DOUBLE PUSH BUTTON

Ürün Kodu	Product Code	010 104 000023
Ambalaj Şekli	Packing Type	Kutu - Pack
Adet	Quantity	10
Ağırlık	Weight	466,5 gr
Hacim	Volume	0,0017



SW-AL7465=24L
22mm PLASTİK İKİZ BUTON LEDLİ (24V AC/DC)
22mm LED DOUBLE PUSH BUTTON

Ürün Kodu	Product Code	010 104 000024
Ambalaj Şekli	Packing Type	Kutu - Pack
Adet	Quantity	10
Ağırlık	Weight	466,5 gr
Hacim	Volume	0,0017



SW-AD21
PLASTİK KALICI 0-1 MANDAL BUTON / 1NO
SELECTOR SWITCH

Ürün Kodu	Product Code	010 104 000025
Ambalaj Şekli	Packing Type	Kutu - Pack
Adet	Quantity	10
Ağırlık	Weight	351,5 gr
Hacim	Volume	0,0017

SWISS SERİSİ SİNYAL BUTONLARI

SWISS SIGNAL AND CONTROL BUTTONS



SW-AD41
PLASTİK KAYICI 0-1
MANDAL BUTON / 1NO
SELECTOR BUTON / 1NO

Ürün Kodu	Product Code	010 104 000026
Ambalaj Şekli	Packing Type	Kutu - Pack
Adet	Quantity	10
Ağırlık	Weight	351,5 gr
Hacim	Volume	0,0017



SW-AD33
PLASTİK KALICI 2-0-1
MANDAL BUTON / 1NO+1NO
SELECTOR SWITCH / 1NO+1NO

Ürün Kodu	Product Code	010 104 000027
Ambalaj Şekli	Packing Type	Kutu - Pack
Adet	Quantity	10
Ağırlık	Weight	446,5 gr
Hacim	Volume	0,0017



SW-AD53
PLASTİK KAYICI 2-0-1
MANDAL BUTON / 1NO+1NO
SELECTOR SWITCH / 1NO+1NO

Ürün Kodu	Product Code	010 104 000028
Ambalaj Şekli	Packing Type	Kutu - Pack
Adet	Quantity	10
Ağırlık	Weight	446,5 gr
Hacim	Volume	0,0017



SW-AG21
PLASTİK KALICI 0-1 ANAHTARLI
MANDAL BUTON / 1NO
SELECTOR SWITCH WITH KEY / 1NO

Ürün Kodu	Product Code	010 104 000029
Ambalaj Şekli	Packing Type	Kutu - Pack
Adet	Quantity	10
Ağırlık	Weight	556,5 gr
Hacim	Volume	0,0017



SW-AG41
PLASTİK KAYICI 0-1 ANAHTARLI
MANDAL BUTON / 1NO
SELECTOR SWITCH WITH KEY / 1NO

Ürün Kodu	Product Code	010 104 000030
Ambalaj Şekli	Packing Type	Kutu - Pack
Adet	Quantity	10
Ağırlık	Weight	556,5 gr
Hacim	Volume	0,0017



SW-AG33
PLASTİK KALICI 2-0-1 ANAHTARLI
MANDAL BUTON / 1NO+1NO
SELECTOR SWITCH WITH KEY / 1NO+1NO

Ürün Kodu	Product Code	010 104 000031
Ambalaj Şekli	Packing Type	Kutu - Pack
Adet	Quantity	10
Ağırlık	Weight	651,5 gr
Hacim	Volume	0,0017



SW-AG53
PLASTİK KAYICI 2-0-1
MANDAL BUTON / 1NO+1NO
SELECTOR SWITCH WITH KEY / 1NO+1NO

Ürün Kodu	Product Code	010 104 000032
Ambalaj Şekli	Packing Type	Kutu - Pack
Adet	Quantity	10
Ağırlık	Weight	651,5 gr
Hacim	Volume	0,0017



SW-AC42
22mm PLASTİK KAYICI
MANDAL BUTON / 1NC
22mm EMERGENCY STOP BUTTON / 1NC

Ürün Kodu	Product Code	010 104 000033
Ambalaj Şekli	Packing Type	Kutu - Pack
Adet	Quantity	10
Ağırlık	Weight	514 gr
Hacim	Volume	0,0017



SW-AC42
22mm PLASTİK KAYICI
MANDAL BUTON / 1NO
22mm EMERGENCY STOP BUTTON / 1NO

Ürün Kodu	Product Code	010 104 000038
Ambalaj Şekli	Packing Type	Kutu - Pack
Adet	Quantity	10
Ağırlık	Weight	514 gr
Hacim	Volume	0,0017



SW-AC51
22mm PLASTİK KAYICI MANDAL BUTON / 1NO
22mm EMERGENCY STOP WITH KEY BUTTON

Ürün Kodu	Product Code	010 104 000039
Ambalaj Şekli	Packing Type	Kutu - Pack
Adet	Quantity	10
Ağırlık	Weight	514 gr
Hacim	Volume	0,0017



SW-AS142
40mm KAFA PLASTİK ANAHTARLIMANDAL BUTON
AÇIL STOP / 1NC
40mm EMERGENCY STOP WITH KEY BUTTON / 1NC

Ürün Kodu	Product Code	010 104 000033
Ambalaj Şekli	Packing Type	Kutu - Pack
Adet	Quantity	10
Ağırlık	Weight	511,5 gr
Hacim	Volume	0,0017



SW-AS542E
40mm KAFA PLASTİK MANDAL BUTON
AÇIL STOP ETİKETLİ- / 1NC
40mm EMERGENCY STOP BUTTON / 1NC

Ürün Kodu	Product Code	010 104 000034
Ambalaj Şekli	Packing Type	Kutu - Pack
Adet	Quantity	10
Ağırlık	Weight	479,5 gr
Hacim	Volume	0,0017



SW-A5442
40mm KAFA PLASTİK MANDAL BUTON
ACİL STOP- / 1NC
40mm EMERGENCY STOP BUTTON / 1NC

Ürün Kodu	Product Code	010 104 000035
Ambalaj Şekli	Packing Type	Kutu - Pack
Adet	Quantity	10
Ağırlık	Weight	476,5 gr
Hacim	Volume	0,0017



SW-A5442
30mm KAFA PLASTİK MANDAL BUTON
ACİL STOP- / 1NC
30mm EMERGENCY STOP BUTTON / 1NC

Ürün Kodu	Product Code	010 104 000036
Ambalaj Şekli	Packing Type	Kutu - Pack
Adet	Quantity	10
Ağırlık	Weight	473,5 gr
Hacim	Volume	0,0017



SW-AW3475
22mm LEDLİ IŞIKLI YAYLI BUTON
110-240V AC / 1NC
22mm PUSH BUTTON LED 110-240V AC / 1NC

Ürün Kodu	Product Code	010 104 000040
Ambalaj Şekli	Packing Type	Kutu - Pack
Adet	Quantity	10
Ağırlık	Weight	389,5 gr
Hacim	Volume	0,0009



SW-AW3475
22mm LEDLİ IŞIK YAYLI BUTON 10-30V DC / 1NC
22mm PUSH BUTTON LED 10-30V DC / 1NC

Ürün Kodu	Product Code	010 104 000041
Ambalaj Şekli	Packing Type	Kutu - Pack
Adet	Quantity	10
Ağırlık	Weight	389,5 gr
Hacim	Volume	0,0009



SW-AW3375
22mm LEDLİ IŞIKLI YAYLI BUTON 110-240V AC / 1NO
22mm PUSH BUTTON LED 110-240V AC / 1NO

Ürün Kodu	Product Code	010 104 000042
Ambalaj Şekli	Packing Type	Kutu - Pack
Adet	Quantity	10
Ağırlık	Weight	389,5 gr
Hacim	Volume	0,0009



SW-AW3375-24
22mm LEDLİ IŞIKLI YAYLI BUTON 10-30V AC / 1NO
22mm PUSH BUTTON LED 10-30V AC / 1NO

Ürün Kodu	Product Code	010 104 000043
Ambalaj Şekli	Packing Type	Kutu - Pack
Adet	Quantity	10
Ağırlık	Weight	389,5 gr
Hacim	Volume	0,0009



SW-AW3575
22mm LEDLİ IŞIKLI YAYLI BUTON 110-240V AC / 1NO
22mm PUSH BUTTON LED 110-240V AC / 1NO

Ürün Kodu	Product Code	010 104 000044
Ambalaj Şekli	Packing Type	Kutu - Pack
Adet	Quantity	10
Ağırlık	Weight	389,5 gr
Hacim	Volume	0,0009



SW-AW3575-24
22mm LEDLİ IŞIKLI YAYLI BUTON 10-30V AC / 1NO
22mm PUSH BUTTON LED 10-30V AC / 1NO

Ürün Kodu	Product Code	010 104 000045
Ambalaj Şekli	Packing Type	Kutu - Pack
Adet	Quantity	10
Ağırlık	Weight	389,5 gr
Hacim	Volume	0,0009



SW-AW3675
22mm LEDLİ IŞIKLI YAYLI BUTON 110-240V AC / 1NO
22mm PUSH BUTTON LED 110-240V AC / OFF-1NC

Ürün Kodu	Product Code	010 104 000046
Ambalaj Şekli	Packing Type	Kutu - Pack
Adet	Quantity	10
Ağırlık	Weight	389,5 gr
Hacim	Volume	0,0009



SW-AW3675-24
22mm LEDLİ IŞIKLI YAYLI BUTON 10-30V AC / 1NO
22mm PUSH BUTTON LED 10-30V AC / 1NO

Ürün Kodu	Product Code	010 104 000047
Ambalaj Şekli	Packing Type	Kutu - Pack
Adet	Quantity	10
Ağırlık	Weight	389,5 gr
Hacim	Volume	0,0009



SW-AK323L
PLASTİK LEDLİ KALICI 1-0-2 MANDAL BUTON
110-240V AC / 2NO
LED SELECTOR SWITCH 1-0-2 / 110-240V AC / 2NO

Ürün Kodu	Product Code	010 104 000054
Ambalaj Şekli	Packing Type	Kutu - Pack
Adet	Quantity	10
Ağırlık	Weight	521,5 gr
Hacim	Volume	0,0017



SW-AK324L
PLASTİK LEDLİ KALICI 1-0-2 MANDAL BUTON
110-240V AC / 2NC
LED SELECTOR SWITCH 1-0-2 / 110-240V AC / 2NC

Ürün Kodu	Product Code	010 104 000055
Ambalaj Şekli	Packing Type	Kutu - Pack
Adet	Quantity	10
Ağırlık	Weight	521,5 gr
Hacim	Volume	0,0017



**SW-AK325L PLASTİK LEDLİ KALICI
1-0-2 MANDAL BUTON 10-24V AC/DC / 2NO**

LED SELECTOR SWITCH 1-0-2 / 10-24V AC/DC / 2NO

Ürün Kodu	Product Code	010 104 000059
Ambalaj Şekli	Packing Type	Kutu - Pack
Adet	Quantity	10
Ağırlık	Weight	521,5 gr
Hacim	Volume	0,0017



**SW-AK123L PLASTİK LEDLİ KALICI
0-1 MANDAL BUTON 110-240V AC / 1NO**

LED SELECTOR SWITCH 0-1 / 110-240V AC / OFF-1NC

Ürün Kodu	Product Code	010 104 000048
Ambalaj Şekli	Packing Type	Kutu - Pack
Adet	Quantity	10
Ağırlık	Weight	421,5 gr
Hacim	Volume	0,0017



**SW-AK124L PLASTİK LEDLİ KALICI
0-1 MANDAL BUTON 110-240V AC / 1NC**

LED SELECTOR SWITCH 0-1 / 110-240 AC / 1NC

Ürün Kodu	Product Code	010 104 000049
Ambalaj Şekli	Packing Type	Kutu - Pack
Adet	Quantity	10
Ağırlık	Weight	421,5 gr
Hacim	Volume	0,0017



**SW-AK125L PLASTİK LEDLİ KALICI
0-1 MANDAL BUTON 110-240V AC / 1NO**

LED SELECTOR SWITCH 0-1 / 110-240V AC / 1NO

Ürün Kodu	Product Code	010 104 000050
Ambalaj Şekli	Packing Type	Kutu - Pack
Adet	Quantity	10
Ağırlık	Weight	421,5 gr
Hacim	Volume	0,0017



**SW-AK123-24L PLASTİK LEDLİ KALICI
0-1 MANDAL BUTON 10-24V AC/DC / 1NO**

LED SELECTOR SWITCH 0-1 / 10-24V AC/DC / 1NO

Ürün Kodu	Product Code	010 104 000051
Ambalaj Şekli	Packing Type	Kutu - Pack
Adet	Quantity	10
Ağırlık	Weight	421,5 gr
Hacim	Volume	0,0017



**SW-AK124-24L PLASTİK LEDLİ KALICI
0-1 MANDAL BUTON 10-24V AC/DC / 1NC**

LED SELECTOR SWITCH 0-1 / 10-24V AC/DC / 1NC

Ürün Kodu	Product Code	010 104 000052
Ambalaj Şekli	Packing Type	Kutu - Pack
Adet	Quantity	10
Ağırlık	Weight	421,5 gr
Hacim	Volume	0,0017



**SW-AK125-24L PLASTİK LEDLİ KALICI
0-1 MANDAL BUTON 10-24V AC/DC / 1NO**

LED SELECTOR SWITCH 0-1 / 110-240V AC/DC / 1NO

Ürün Kodu	Product Code	010 104 000053
Ambalaj Şekli	Packing Type	Kutu - Pack
Adet	Quantity	10
Ağırlık	Weight	421,5 gr
Hacim	Volume	0,0017



**SW-BA42
22mm YAYLI BUTON / 1NC
22mm PUSH BUTTON / 1NC**

Ürün Kodu	Product Code	010 104 000064
Ambalaj Şekli	Packing Type	Kutu - Pack
Adet	Quantity	10
Ağırlık	Weight	284,5 gr
Hacim	Volume	0,0009



**SW-BA31
22mm YAYLI BUTON / 1NO
22mm PUSH BUTTON / 1NO**

Ürün Kodu	Product Code	010 104 000065
Ambalaj Şekli	Packing Type	Kutu - Pack
Adet	Quantity	10
Ağırlık	Weight	284,5 gr
Hacim	Volume	0,0009



**SW-BA4322
22mm İŞARETLİ YAYLI BUTON / 1NC**

22mm PUSH BUTTON MATTEL PRINTING / 1NC

Ürün Kodu	Product Code	010 104 000071
Ambalaj Şekli	Packing Type	Kutu - Pack
Adet	Quantity	10
Ağırlık	Weight	284,5 gr
Hacim	Volume	0,0009



**SW-BA3351
22mm İŞARETLİ YAYLI BUTON / 1NC**

22mm PUSH BUTTON MATTEL PRINTING / 1NC

Ürün Kodu	Product Code	010 104 000072
Ambalaj Şekli	Packing Type	Kutu - Pack
Adet	Quantity	10
Ağırlık	Weight	284,5 gr
Hacim	Volume	0,0009



**SW-BA3341
22mm İŞARETLİ YAYLI BUTON / 1NO**

22mm PUSH BUTTON MATTEL PRINTING / 1NO

Ürün Kodu	Product Code	010 104 000073
Ambalaj Şekli	Packing Type	Kutu - Pack
Adet	Quantity	10
Ağırlık	Weight	284,5 gr
Hacim	Volume	0,0009



SW-B A3371
22mm YAYLI BUTON / 1NO+1NO
22mm PUSH BUTTON PRINTING / 1NO+1NO

Ürün Kodu	Product Code	010 104 000083
Ambalaj Şekli	Packing Type	Kutu - Pack
Adet	Quantity	10
Ağırlık	Weight	461,5 gr
Hacim	Volume	0,0017



SW-B A3381
22mm İŞARETLİ YAYLI BUTON / 1NO
22mm PUSH BUTTON PRINTING / 1NO+1NO

Ürün Kodu	Product Code	010 104 000084
Ambalaj Şekli	Packing Type	Kutu - Pack
Adet	Quantity	10
Ağırlık	Weight	461,5 gr
Hacim	Volume	0,0017



SW-B L7325
22mm PLASTİK İKİZ BUTON 220V / AC / 1NO+1NC
22mm DOUBLE PUSH BUTTON 220V / AC / 1NO+1NC

Ürün Kodu	Product Code	010 104 000085
Ambalaj Şekli	Packing Type	Kutu - Pack
Adet	Quantity	10
Ağırlık	Weight	461,5 gr
Hacim	Volume	0,0017



SW-B A3361
22mm İŞARETLİ YAYLI BUTON / 1NO
22mm PUSH BUTTON MATTEL PRINTING / 1NO

Ürün Kodu	Product Code	010 104 000074
Ambalaj Şekli	Packing Type	Kutu - Pack
Adet	Quantity	10
Ağırlık	Weight	284,5 gr
Hacim	Volume	0,0009



SW-B A3371
22mm İŞARETLİ YAYLI BUTON / 1NO
22mm PUSH BUTTON MATTEL PRINTING / 1NO

Ürün Kodu	Product Code	010 104 000075
Ambalaj Şekli	Packing Type	Kutu - Pack
Adet	Quantity	10
Ağırlık	Weight	284,5 gr
Hacim	Volume	0,0009



SW-B A3381
22mm İŞARETLİ YAYLI BUTON / 1NO
22mm PUSH BUTTON MATTEL PRINTING / 1NO

Ürün Kodu	Product Code	010 104 000076
Ambalaj Şekli	Packing Type	Kutu - Pack
Adet	Quantity	10
Ağırlık	Weight	284,5 gr
Hacim	Volume	0,0009



SW-B L7325
22mm PLASTİK İKİZ BUTON / 1NO+1NC
22mm DOUBLE PUSH BUTTON / 1NO+1NC

Ürün Kodu	Product Code	010 104 000077
Ambalaj Şekli	Packing Type	Kutu - Pack
Adet	Quantity	10
Ağırlık	Weight	461,5 gr
Hacim	Volume	0,0017



SW-B L7425
22mm PLASTİK İKİZ BUTON / 1NO+1NC
22mm DOUBLE PUSH BUTTON / 1NO+1NC

Ürün Kodu	Product Code	010 104 000078
Ambalaj Şekli	Packing Type	Kutu - Pack
Adet	Quantity	10
Ağırlık	Weight	461,5 gr
Hacim	Volume	0,0017



SW-B L7525
22mm PLASTİK İKİZ BUTON / 1NO+1NC
22mm DOUBLE PUSH BUTTON / 1NO+1NC

Ürün Kodu	Product Code	010 104 000079
Ambalaj Şekli	Packing Type	Kutu - Pack
Adet	Quantity	10
Ağırlık	Weight	461,5 gr
Hacim	Volume	0,0017



SW-B L4151
PLASTİK YUKARI AŞAĞI OKLU İKİZ BUTON / 1NO+1NO
DOUBLE PUSH PRINTING / 1NO+1NO

Ürün Kodu	Product Code	010 104 000080
Ambalaj Şekli	Packing Type	Kutu - Pack
Adet	Quantity	10
Ağırlık	Weight	461,5 gr
Hacim	Volume	0,0017



SW-B L4252
PLASTİK YUKARI AŞAĞI OKLU İKİZ BUTON / 1NO+1NO
DOUBLE PUSH PRINTING / 1NO+1NO

Ürün Kodu	Product Code	010 104 000003
Ambalaj Şekli	Packing Type	Kutu - Pack
Adet	Quantity	10
Ağırlık	Weight	461,5 gr
Hacim	Volume	0,0017



SW-B A3361
22mm İŞARETLİ YAYLI BUTON / 1NO+1NO
22mm PUSH BUTTON PRINTING / 1NO+1NO

Ürün Kodu	Product Code	010 104 000082
Ambalaj Şekli	Packing Type	Kutu - Pack
Adet	Quantity	10
Ağırlık	Weight	461,5 gr
Hacim	Volume	0,0017



SW-BL7425

22mm PLASTİK İKİZ BUTON / 1NO+1NC

22mm DOUBLE PUSH BUTTON PRINTING / 1NO+1NC

Ürün Kodu	Product Code	010 104 000086
Ambalaj Şekli	Packing Type	Kutu - Pack
Adet	Quantity	10
Ağırlık	Weight	461,5 gr
Hacim	Volume	0,0017



SW-BD21

0-1 KALICI MANDAL BUTON / 1NO

0-1 SELECTOR SWITCH / 1NO

Ürün Kodu	Product Code	010 104 000087
Ambalaj Şekli	Packing Type	Kutu - Pack
Adet	Quantity	10
Ağırlık	Weight	351,5 gr
Hacim	Volume	0,0017



SW-BD41

0-1 KALICI MANDAL BUTON / 1NO

0-1 SELECTOR SWITCH / 1NO

Ürün Kodu	Product Code	010 104 000088
Ambalaj Şekli	Packing Type	Kutu - Pack
Adet	Quantity	10
Ağırlık	Weight	351,5 gr
Hacim	Volume	0,0017



SW-BD33

0-1-2 KALICI MANDAL BUTON / 1NO+1NO

0-1-2 SELECTOR SWITCH / 1NO+1NO

Ürün Kodu	Product Code	010 104 000089
Ambalaj Şekli	Packing Type	Kutu - Pack
Adet	Quantity	10
Ağırlık	Weight	446,5 gr
Hacim	Volume	0,0017



SW-BD53

0-1-2 KALICI MANDAL BUTON / 1NO+1NO

0-1-2 SELECTOR SWITCH / 1NO+1NO

Ürün Kodu	Product Code	010 104 000090
Ambalaj Şekli	Packing Type	Kutu - Pack
Adet	Quantity	10
Ağırlık	Weight	446,5 gr
Hacim	Volume	0,0017



SW-BK123L

0-1 LEDLİ İŞIKLI KALICI MANDAL BUTON 110-240V AC / 1NO

0-1 LED SELECTOR SWITCH 110-240 AC / 1NO

Ürün Kodu	Product Code	010 104 000168
Ambalaj Şekli	Packing Type	Kutu - Pack
Adet	Quantity	10
Ağırlık	Weight	421,5 gr
Hacim	Volume	0,0017



SW-BK124L 0-1 LEDLİ İŞIKLI KALICI MANDAL BUTON 110-240V AC / 1NO

0-1 LED SELECTOR SWITCH 110-240V AC / 1NO

Ürün Kodu	Product Code	010 104 000169
Ambalaj Şekli	Packing Type	Kutu - Pack
Adet	Quantity	10
Ağırlık	Weight	421,5 gr
Hacim	Volume	0,0017



SW-BK125L 0-1 LEDLİ İŞIKLI KALICI MANDAL BUTON 110-240V AC / 1NO

0-1 LED SELECTOR SWITCH 110-240V AC / 1NO

Ürün Kodu	Product Code	010 104 000170
Ambalaj Şekli	Packing Type	Kutu - Pack
Adet	Quantity	10
Ağırlık	Weight	421,5 gr
Hacim	Volume	0,0017



SW-BK123L-24L 0-1 LEDLİ İŞIKLI KALICI MANDAL BUTON 10-30V AC/DC / 1NO

0-1 LED SELECTOR SWITCH 10-30V AC/DC / 1NO

Ürün Kodu	Product Code	010 104 000171
Ambalaj Şekli	Packing Type	Kutu - Pack
Adet	Quantity	10
Ağırlık	Weight	421,5 gr
Hacim	Volume	0,0017



SW-BK124L-24L 0-1 LEDLİ İŞIKLI KALICI MANDAL BUTON 10-30V AC/DC / 1NC

0-1 LED SELECTOR SWITCH 10-30V AC/DC / 1NC

Ürün Kodu	Product Code	010 104 000172
Ambalaj Şekli	Packing Type	Kutu - Pack
Adet	Quantity	10
Ağırlık	Weight	421,5 kg
Hacim	Volume	0,0017



SW-BK125L-24L 0-1 LEDLİ İŞIKLI KALICI MANDAL BUTON 10-30V AC/DC / 1NC

0-1 LED SELECTOR SWITCH 10-30V AC/DC / 1NC

Ürün Kodu	Product Code	010 104 000173
Ambalaj Şekli	Packing Type	Kutu - Pack
Adet	Quantity	10
Ağırlık	Weight	421,5 gr
Hacim	Volume	0,0017



SW-BW3475 22mm LEDLİ İŞIKLI YAYLI BUTON 110-240V AC / STOP

22mm PUSH BUTTON LED 110-240V AC / STOP

Ürün Kodu	Product Code	010 104 000160
Ambalaj Şekli	Packing Type	Kutu - Pack
Adet	Quantity	10
Ağırlık	Weight	389,5 gr
Hacim	Volume	0,0009



SW-BW3475-24L 22mm LEDLİ İŞIKLI YAYLI BUTON 10-30V AC/DC / STOP
22mm PUSH BUTTON LED 10-30V AC/DC / STOP

Ürün Kodu	Product Code	010 104 000161
Ambalaj Şekli	Packing Type	Kutu - Pack
Adet	Quantity	10
Ağırlık	Weight	389,5 gr
Hacim	Volume	0,0009



SW-BW3375 22mm LEDLİ İŞIKLI YAYLI BUTON 110-240V AC / START
22mm PUSH BUTTON LED 110-240V AC / START

Ürün Kodu	Product Code	010 104 000162
Ambalaj Şekli	Packing Type	Kutu - Pack
Adet	Quantity	10
Ağırlık	Weight	389,5 gr
Hacim	Volume	0,0009



SW-BW3375 22mm LEDLİ İŞIKLI YAYLI BUTON 10-30V AC/DC / START
22mm PUSH BUTTON LED 10-30V AC/DC / START

Ürün Kodu	Product Code	010 104 000163
Ambalaj Şekli	Packing Type	Kutu - Pack
Adet	Quantity	10
Ağırlık	Weight	389,5 gr
Hacim	Volume	0,0009



SW-BW3575 22mm LEDLİ İŞIKLI YAYLI BUTON 110-240V AC / START
22mm PUSH BUTTON LED 110-240V AC / START

Ürün Kodu	Product Code	010 104 000164
Ambalaj Şekli	Packing Type	Kutu - Pack
Adet	Quantity	10
Ağırlık	Weight	389,5 gr
Hacim	Volume	0,0009



SW-BW-357524L 22mm LEDLİ İŞIKLI YAYLI BUTON 10-30V AC/DC / START
22mm PUSH BUTTON LED 10-30V AC/DC / START

Ürün Kodu	Product Code	010 104 000165
Ambalaj Şekli	Packing Type	Kutu - Pack
Adet	Quantity	10
Ağırlık	Weight	389,5 gr
Hacim	Volume	0,0009



SW-BW367522mm LEDLİ İŞIKLI YAYLI BUTON START 110-240V AC / START
22mm PUSH BUTTON LED 110-240V AC / START

Ürün Kodu	Product Code	010 104 000166
Ambalaj Şekli	Packing Type	Kutu - Pack
Adet	Quantity	10
Ağırlık	Weight	389,5 gr
Hacim	Volume	0,0009



SW-BW-367524L 22mm LEDLİ İŞIKLI YAYLI BUTON 10-30V AC/DC / START
22mm PUSH BUTTON LED 10-30V AC/DC / START

Ürün Kodu	Product Code	010 104 000167
Ambalaj Şekli	Packing Type	Kutu - Pack
Adet	Quantity	10
Ağırlık	Weight	389,5 gr
Hacim	Volume	0,0009



SW-BK323L 1-0-2 PLASTİK LEDLİ KALICI MANDAL BUTON 110-240V AC / 2NO
1-0-2 LED SELECTOR SWITCH 110-240V AC / 2NO

Ürün Kodu	Product Code	010 104 000174
Ambalaj Şekli	Packing Type	Kutu - Pack
Adet	Quantity	10
Ağırlık	Weight	521,5 gr
Hacim	Volume	0,0017



SW-BK324L1-0-2 PLASTİK LEDLİ KALICI MANDAL BUTON 110-240V AC / 2NC
1-0-2 LED SELECTOR SWITCH 110-240V AC / 2NC

Ürün Kodu	Product Code	010 104 000175
Ambalaj Şekli	Packing Type	Kutu - Pack
Adet	Quantity	10
Ağırlık	Weight	521,5 gr
Hacim	Volume	0,0017



SW-BK325L 1-0-2 PLASTİK LEDLİ KALICI MANDAL BUTON 110-240V AC / 2NO
1-0-2 LED SELECTOR SWITCH 110-240V AC / 2NO

Ürün Kodu	Product Code	010 104 000176
Ambalaj Şekli	Packing Type	Kutu - Pack
Adet	Quantity	10
Ağırlık	Weight	521,5 gr
Hacim	Volume	0,0017



SW-BK323-24L 1-0-2 PLASTİK LEDLİ KALICI MANDAL BUTON 10-24V AC/DC / 2NO
1-0-2 LED SELECTOR SWITCH 10-24V AC/DC / 2NO

Ürün Kodu	Product Code	010 104 000177
Ambalaj Şekli	Packing Type	Kutu - Pack
Adet	Quantity	10
Ağırlık	Weight	521,5 gr
Hacim	Volume	0,0017



SW-BK324-24L 1-0-2 PLASTİK LEDLİ KALICI MANDAL BUTON 10-24V AC/DC / 2NC
1-0-2 LED SELECTOR SWITCH 10-24V AC/DC / 2NC

Ürün Kodu	Product Code	010 104 000178
Ambalaj Şekli	Packing Type	Kutu - Pack
Adet	Quantity	10
Ağırlık	Weight	521,5 gr
Hacim	Volume	0,0017



SW-BK325-24L 1-0-2 PLASTİK LEDLİ KALICI MANDAL BUTON 10-24V AC/DC / 2NO
1-0-2 LED SELECTOR SWITCH 10-24V AC/DC / 2NO

Ürün Kodu	Product Code	010 104 000179
Ambalaj Şekli	Packing Type	Kutu - Pack
Adet	Quantity	10
Ağırlık	Weight	521,5 gr
Hacim	Volume	0,0017



SW-AP2
BUTON KORUMA KILIFI
(YAYLI BUTONLAR İÇİN)

SILICONE DUST COVER (FOR SPRING BUTTON)

Ürün Kodu	Product Code	010 093 000001
Ambalaj Şekli	Packing Type	Kutu - Pack
Adet	Quantity	50
Ağırlık	Weight	100,04 gr
Hacim	Volume	0,0009



SW-AP4
İKİZ BUTON KORUMA KILIFI
(YAYLI BUTONLAR İÇİN)

TWIN BUTTON PROTECTION (FOR SPRING BUTTON)

Ürün Kodu	Product Code	010 093 000099
Ambalaj Şekli	Packing Type	Kutu - Pack
Adet	Quantity	50
Ağırlık	Weight	250,04 gr
Hacim	Volume	0,0009



SW-BRY
PLASTİK YAZILI BUTON ROZETİ
BUTTON LABEL

Ürün Kodu	Product Code	010 093 000002
Ambalaj Şekli	Packing Type	Kutu - Pack
Adet	Quantity	100
Ağırlık	Weight	150,04 gr
Hacim	Volume	0,0009

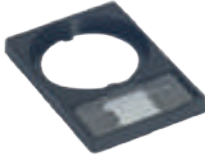

SW-BR1
PLASTİK BUTON ROZETİ 26X8 CAMLI
PLASTIC COVER BUTTON 26X8

Ürün Kodu	Product Code	010 104 000091
Ambalaj Şekli	Packing Type	Kutu - Pack
Adet	Quantity	100
Ağırlık	Weight	450,04 gr
Hacim	Volume	0,0009

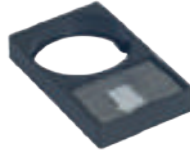

SW-BR2
PLASTİK BUTON ROZETİ 26X18 CAMLI
PLASTIC COVER BUTTON 26X18

Ürün Kodu	Product Code	010 104 000092
Ambalaj Şekli	Packing Type	Kutu - Pack
Adet	Quantity	100
Ağırlık	Weight	250,04 gr
Hacim	Volume	0,0009

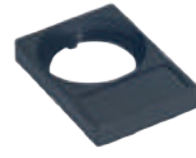

SW-SİE-R
PLASTİK BUTON ROZETİ 27X12 CAMLI
PLASTIC COVER BUTTON 27X12

Ürün Kodu	Product Code	010 104 000093
Ambalaj Şekli	Packing Type	Kutu - Pack
Adet	Quantity	100
Ağırlık	Weight	150,04 gr
Hacim	Volume	0,0009



ACİL DURDURMA ETİKETİ
EMERGENCY STOP LABEL

Ürün Kodu	Product Code	010 093 000003
Ambalaj Şekli	Packing Type	Kutu - Pack
Adet	Quantity	50
Ağırlık	Weight	200,04 gr
Hacim	Volume	0,0009



SW-ER60TE
Ø60mm PLASTİK ACİL DURDURMA +
EMERGENCY ROZETİ (KALIN TİP) LAZER BASKI
PUSH BUTTON MATEL PRINTING

Ürün Kodu	Product Code	010 104 000095
Ambalaj Şekli	Packing Type	Kutu - Pack
Adet	Quantity	50
Ağırlık	Weight	300,04 gr
Hacim	Volume	0,0009



SW-ER60EN-Y
Ø60mm PLASTİK EMERGENCY
ROZETİ (İNCE TİP) LAZER BASKI
Ø60mm EMERGENCY STOP LABEL

Ürün Kodu	Product Code	010 104 000096
Ambalaj Şekli	Packing Type	Kutu - Pack
Adet	Quantity	50
Ağırlık	Weight	275,04 gr
Hacim	Volume	0,0009



SW-AKKM
EMNİYET BASMA DÜĞMESİ MUHAFAZA
EMERGENCY STOP PROTECTIVE COVER

Ürün Kodu	Product Code	010 090 050008
Ambalaj Şekli	Packing Type	Kutu - Pack
Adet	Quantity	50
Ağırlık	Weight	300,04 gr
Hacim	Volume	0,0009



SW-AKK
ACİL STOP KORUMA KAPAĞI
EMERGENCY STOP PROTECTIVE COVER

Ürün Kodu	Product Code	010 104 000101
Ambalaj Şekli	Packing Type	Kutu - Pack
Adet	Quantity	50
Ağırlık	Weight	300,04 gr
Hacim	Volume	0,0009



SW-AKKY
ACİL STOP KORUMA KAPAĞI
EMERGENCY STOP PROTECTIVE COVER

Ürün Kodu	Product Code	010 104 000102
Ambalaj Şekli	Packing Type	Kutu - Pack
Adet	Quantity	50
Ağırlık	Weight	300,04 gr
Hacim	Volume	0,0009



SW-ASKK
ACİL STOP KORUMA KAPAĞI (YARIM AY ŞEKLİNDE)
EMERGENCY STOP PROTECTIVE COVER

Ürün Kodu	Product Code	010 104 000103
Ambalaj Şekli	Packing Type	Kutu - Pack
Adet	Quantity	20
Ağırlık	Weight	300,04 gr
Hacim	Volume	0,0009



SW-MKKY
MANDAL BUTON KORUMA KAPAĞI
EMERGENCY STOP PROTECTIVE COVER

Ürün Kodu	Product Code	010 104 000104
Ambalaj Şekli	Packing Type	Kutu - Pack
Adet	Quantity	50
Ağırlık	Weight	300,04 gr
Hacim	Volume	0,0009



SW-BE101
KONTAK BLOK / NO
AUXILIARY CONTACT / NO

Ürün Kodu	Product Code	010 104 000060
Ambalaj Şekli	Packing Type	Kutu - Pack
Adet	Quantity	50
Ağırlık	Weight	551,5 gr
Hacim	Volume	0,0017



SW-BE102
KONTAK BLOK / NC
AUXILIARY CONTACT / NC

Ürün Kodu	Product Code	010 104 000061
Ambalaj Şekli	Packing Type	Kutu - Pack
Adet	Quantity	50
Ağırlık	Weight	551,5 gr
Hacim	Volume	0,0017



SW-BE103
IŞIK SOKETİ 10/30 110-240V AC
AUXILIARY LED CONTACT / NO

Ürün Kodu	Product Code	010 104 000062
Ambalaj Şekli	Packing Type	Kutu - Pack
Adet	Quantity	50
Ağırlık	Weight	501,5 gr
Hacim	Volume	0,0017



22mm VOLTMETRE PLASTİK LED GÖSTERGELİ 20-500V AC
22mm VOLTMETER PLASTIC LED INDICATOR 20-500V AC

Ürün Kodu	Product Code	999 999 995000
Ambalaj Şekli	Packing Type	Kutu - Pack
Adet	Quantity	10
Ağırlık	Weight	74,5 gr
Hacim	Volume	0,0017



22mm AMPERMETRE (AKIM TRAFOLU) PLS. LED GÖS. 1A-100A AC/60-380V AC
22mm AMMETER (WITH CURRENT TRANSFORMER) PLASTIC LED INDICATOR 12-500V AC

Ürün Kodu	Product Code	999 999 995001
Ambalaj Şekli	Packing Type	Kutu - Pack
Adet	Quantity	10
Ağırlık	Weight	74,5 gr
Hacim	Volume	0,0017



22mm VOLT+AMPERMETRE AKIM TRAFOLU PLS. LED GÖS. 12A-500V AC/1A-100A AC
22mm VOLTMETER+AMMETER (CURRENT TRANS.) PLASTIC LED INDICATOR 1A-100A AC

Ürün Kodu	Product Code	999 999 995002
Ambalaj Şekli	Packing Type	Kutu - Pack
Adet	Quantity	10
Ağırlık	Weight	74,5 gr
Hacim	Volume	0,0017



POTANS 5K MS-22-5K
POTANS 5K

Ürün Kodu	Product Code	010 104 000001
Ambalaj Şekli	Packing Type	Kutu - Pack
Adet	Quantity	15
Ağırlık	Weight	
Hacim	Volume	



POTANS 10K MAS-22-10K
POTANS 10K

Ürün Kodu	Product Code	010 104 000002
Ambalaj Şekli	Packing Type	Kutu - Pack
Adet	Quantity	15
Ağırlık	Weight	
Hacim	Volume	





MS-KK31
1'Lİ KUTULU START BUTONU / 1NO
PUSH BUTTON ON IN HOIST / 1NO

Ürün Kodu	Product Code	010 104 000120
Ambalaj Şekli	Packing Type	Kutu - Pack
Adet	Quantity	18
Ağırlık	Weight	1,740 kg
Hacim	Volume	0,0100



MS-KK42
1'Lİ KUTULU STOP BUTONU / 1NC
PUSH BUTTON OFF IN HOIST / 1NC

Ürün Kodu	Product Code	010 104 000121
Ambalaj Şekli	Packing Type	Kutu - Pack
Adet	Quantity	18
Ağırlık	Weight	1,740 kg
Hacim	Volume	0,0100



MS-KK51
1'Lİ KUTULU START BUTONU / 1NO
PUSH BUTTON ON IN HOIST / 1NO

Ürün Kodu	Product Code	010 104 000122
Ambalaj Şekli	Packing Type	Kutu - Pack
Adet	Quantity	18
Ağırlık	Weight	1,740 kg
Hacim	Volume	0,0100



MS-BX71
1'Lİ KUTULU ALARM BUTONU / 1NO
PUSH BUTTON ON IN HOIST PRINTING / 1NO

Ürün Kodu	Product Code	010 104 000123
Ambalaj Şekli	Packing Type	Kutu - Pack
Adet	Quantity	18
Ağırlık	Weight	1,740 kg
Hacim	Volume	0,0100



MS-BX81
1'Lİ KUTULU AYDINLATMA BUTONU / 1NO
PUSH BUTTON ON IN HOIST PRINTING / 1NO

Ürün Kodu	Product Code	010 104 000124
Ambalaj Şekli	Packing Type	Kutu - Pack
Adet	Quantity	18
Ağırlık	Weight	1,740 kg
Hacim	Volume	0,0100



MS-KK7325
1'Lİ KUTULU İKİZ BUTONU / 1NO+1NC
DOUBLE PUSH BUTTON ON-OFF PRINTING / 1NO+1NC

Ürün Kodu	Product Code	010 104 000125
Ambalaj Şekli	Packing Type	Kutu - Pack
Adet	Quantity	18
Ağırlık	Weight	2,47 kg
Hacim	Volume	0,0100



MS-KK4151 1'Lİ KUTULU İŞARETLİ İKİZ BUTONU / 1NO+1NC
DOUBLE PUSH BUTTON ON-OFF PRINTING / 1NO+1NC

Ürün Kodu	Product Code	010 104 000126
Ambalaj Şekli	Packing Type	Kutu - Pack
Adet	Quantity	18
Ağırlık	Weight	2,47 kg
Hacim	Volume	0,0100



MS-KBZ 1'Lİ KUTULU KABİN ALTI İKAZ LAMBASI BUZZERLİ
LED BUZZER IN HOIST

Ürün Kodu	Product Code	010 104 000127
Ambalaj Şekli	Packing Type	Kutu - Pack
Adet	Quantity	18
Ağırlık	Weight	2,03 kg
Hacim	Volume	0,0100



MS-BX542 1'Lİ KUTULU ACİL STOP BUTONU / 1NC
EMERGENCY STOP IN HOIST / 1NC

Ürün Kodu	Product Code	010 090 050009
Ambalaj Şekli	Packing Type	Kutu - Pack
Adet	Quantity	18
Ağırlık	Weight	2,31 kg
Hacim	Volume	0,0100



MS-BX542E 1'Lİ KUTULU EMERGENCY STOP BUTONU / 1NC
EMERGENCY STOP IN HOIST PRINTING / 1NC

Ürün Kodu	Product Code	010 104 000129
Ambalaj Şekli	Packing Type	Kutu - Pack
Adet	Quantity	18
Ağırlık	Weight	2,32 kg
Hacim	Volume	0,0100



MS-BX542ASP 1'Lİ KUT. MÜHÜRLÜ TİP KOR. ACİL STOP BUTONU / 1NC
EMERGENCY STOP IN HOIST WITH PROTECTIVE COVER / 1NC

Ürün Kodu	Product Code	010 104 000130
Ambalaj Şekli	Packing Type	Kutu - Pack
Adet	Quantity	12
Ağırlık	Weight	1,86 kg
Hacim	Volume	0,0100



MS-BYP3K 1'Lİ KUTULU 3 KADEME BY-PASS ANAHTARI
KEY SELECTOR SWITCH IN HOIST

Ürün Kodu	Product Code	010 104 000131
Ambalaj Şekli	Packing Type	Kutu - Pack
Adet	Quantity	12
Ağırlık	Weight	2,42 kg
Hacim	Volume	0,0100



MS-BYK4K 1'Lİ KUTULU 4 KADEME BY-PASS ANAHTARLI
KEY SELECTOR SWITCH IN HOIST

Ürün Kodu	Product Code	010 104 000132
Ambalaj Şekli	Packing Type	Kutu - Pack
Adet	Quantity	12
Ağırlık	Weight	2,42 kg
Hacim	Volume	0,0100



MS-KANT 1'Lİ KUTULU KAYICI RESET ANAHTARI
RESET BUTTON IN HOIST

Ürün Kodu	Product Code	010 104 000133
Ambalaj Şekli	Packing Type	Kutu - Pack
Adet	Quantity	12
Ağırlık	Weight	1,76 kg
Hacim	Volume	0,0100

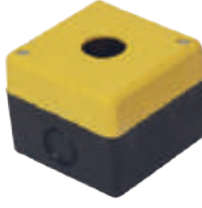

EKO1015
EKO 1'Lİ BOŞ KUMANDA KUTUSU
EKO EMPTY CONTROL BOX

Ürün Kodu	Product Code	010 104 000105
Ambalaj Şekli	Packing Type	Kutu - Pack
Adet	Quantity	90
Ağırlık	Weight	7,56 kg
Hacim	Volume	0,0359



EKO2015
EKO 1'Lİ KORUMALI BOŞ KUMANDA KUTUSU
EKO PROTECTED CONTROL BOX

Ürün Kodu	Product Code	010 104 000106
Ambalaj Şekli	Packing Type	Kutu - Pack
Adet	Quantity	50
Ağırlık	Weight	5,05 kg
Hacim	Volume	0,0359



EKO3015
EKO 1'Lİ ACİL STOP ETİKETİ KOR. YAZILI KUMANDA KUTUSU
EMERGENCY STOP LABEL MARKED CONTROL BOX

Ürün Kodu	Product Code	010 104 000107
Ambalaj Şekli	Packing Type	Kutu - Pack
Adet	Quantity	50
Ağırlık	Weight	7,10 kg
Hacim	Volume	0,0359



EKO4015
EKO 1'Lİ ACİL STOPLU KUMANDA KUTUSU
EMERGENCY STOP CONTROL BOX

Ürün Kodu	Product Code	010 104 000156
Ambalaj Şekli	Packing Type	Kutu - Pack
Adet	Quantity	50
Ağırlık	Weight	7,10 kg
Hacim	Volume	0,0359



1'Lİ ETANJ BUTON KUTUSU EUROBOX
HOIST 1 HOLDER

Ürün Kodu	Product Code	010 091 010001
Ambalaj Şekli	Packing Type	Kutu - Pack
Adet	Quantity	24
Ağırlık	Weight	2,48 kg
Hacim	Volume	0,0100



2'Lİ ETANJ BUTON KUTUSU EUROBOX
HOIST 2 HOLDER

Ürün Kodu	Product Code	010 091 010002
Ambalaj Şekli	Packing Type	Kutu - Pack
Adet	Quantity	18
Ağırlık	Weight	2,55 kg
Hacim	Volume	0,0100



3'LÜ ETANJ BUTON KUTUSU EUROBOX
HOIST 3 HOLDER

Ürün Kodu	Product Code	010 091 010003
Ambalaj Şekli	Packing Type	Kutu - Pack
Adet	Quantity	12
Ağırlık	Weight	1,75 kg
Hacim	Volume	0,0100



4'LÜ ETANJ BUTON KUTUSU EUROBOX
HOIST 4 HOLDER

Ürün Kodu	Product Code	010 091 010004
Ambalaj Şekli	Packing Type	Kutu - Pack
Adet	Quantity	10
Ağırlık	Weight	2,02 kg
Hacim	Volume	0,0100



5'Lİ ETANJ BUTON KUTUSU EUROBOX
HOIST 5 HOLDER

Ürün Kodu	Product Code	010 104 000114
Ambalaj Şekli	Packing Type	Kutu - Pack
Adet	Quantity	8
Ağırlık	Weight	1,32 kg
Hacim	Volume	0,0100



SW-BX065B
6'Lİ ETANJ BUTON KUTUSU EUROBOX
HOIST 6 HOLDER

Ürün Kodu	Product Code	010 104 000115
Ambalaj Şekli	Packing Type	Kutu - Pack
Adet	Quantity	8
Ağırlık	Weight	1,60 kg
Hacim	Volume	0,0100



SW-BX075B
7'Lİ ETANJ BUTON KUTUSU EUROBOX
HOIST 7 HOLDER

Ürün Kodu	Product Code	010 104 000116
Ambalaj Şekli	Packing Type	Kutu - Pack
Adet	Quantity	6
Ağırlık	Weight	1,60 kg
Hacim	Volume	0,0100



SW-BX085B
8'Lİ ETANJ BUTON KUTUSU EUROBOX
HOIST 8 HOLDER

Ürün Kodu	Product Code	010 104 000117
Ambalaj Şekli	Packing Type	Kutu - Pack
Adet	Quantity	6
Ağırlık	Weight	1,60 kg
Hacim	Volume	0,0100



SW-BX09SB
9'LU ETANJ BUTON KUTUSU EUROBOX
HOIST 9 HOLDER

Ürün Kodu	Product Code	010 104 000118
Ambalaj Şekli	Packing Type	Kutu - Pack
Adet	Quantity	1
Ağırlık	Weight	312,02 gr
Hacim	Volume	0,0100



SW-BX10SB
10'LU ETANJ BUTON KUTUSU EUROBOX
HOIST 10 HOLDER

Ürün Kodu	Product Code	010 104 000119
Ambalaj Şekli	Packing Type	Kutu - Pack
Adet	Quantity	1
Ağırlık	Weight	312,02 gr
Hacim	Volume	0,0100



MS-KYD02 2'Lİ ASANSÖR KUYU DİBİ
BUTON 220V 16A TOP. PRİZ+ACİL STOP BUTON
2 GANG ELEVATOR PIT BUTTON 220V 16A EARTED SOCKET+EMERGENCY STOP BUTTON

Ürün Kodu	Product Code	010 104 000134
Ambalaj Şekli	Packing Type	Kutu - Pack
Adet	Quantity	09
Ağırlık	Weight	1,85 kg
Hacim	Volume	0,0100



MS-KYD03 ACİL STOP BUTON + SEÇİCİ BUTON
220V 16A TOP. PANO PRİZİ / 2NO
EMERGENCY STOP BUTTON+ SELECT BUT. 220V 16A EARTED PANEL SOCKET / 2NO

Ürün Kodu	Product Code	010 104 000135
Ambalaj Şekli	Packing Type	Kutu - Pack
Adet	Quantity	6
Ağırlık	Weight	1,40 kg
Hacim	Volume	0,0100



MS-KYD04 6'Lİ ACİL STOP BUT. +2 AD. OKLU BUT. (1NO) 1 İKİZ BUT. (2NO) 1 SEÇ. BUT. (2NO)
6 GANG EMERGENCY STOP BUTTON + 2 PIECES OF ARW. BUT. (1NO) 1 TWIN BUT. (2NO) 1 SELECT BUT. (2NO)

Ürün Kodu	Product Code	010 104 000136
Ambalaj Şekli	Packing Type	Kutu - Pack
Adet	Quantity	5
Ağırlık	Weight	1,27 kg
Hacim	Volume	0,0100



MS-KYD05 ACİL STOP BUT. +2 OKLU BUT. ORTAK OKLU (1NO) SEÇ. BUT. (2NO-1NC)
EMERGENCY STOP BUT. +2 ARROWED BUTTON COMMON ARW (1NO) SELECT BUTTON (2NO-1NC)

Ürün Kodu	Product Code	010 104 000137
Ambalaj Şekli	Packing Type	Kutu - Pack
Adet	Quantity	4
Ağırlık	Weight	1,28 kg
Hacim	Volume	0,0100



MS-KYD06 ACİL STOP BUT. +2 OKLU BUT. (2NO) 1 ORTAK BUT. (1NO) ALARM BUT. + SEÇ. BUT. (2NO-1NC)
EMERGENCY STOP +2 ARROWED BUT. (2NO) 1 COMMON BUT. (1NO) ALARM BUT. +SEL. BUT. (2NO-1NC)

Ürün Kodu	Product Code	010 104 000138
Ambalaj Şekli	Packing Type	Kutu - Pack
Adet	Quantity	2
Ağırlık	Weight	566,02 gr
Hacim	Volume	0,0100



KY2-ALR KORUMALI ACİL STOP BUT. (1NC) NO KONTAKLI ALARM BUTONU KOMBİNASYON
PROTECTED EMERGENCY STOP (1NC) NO CONTACTED ALARM BUTTON COMBINATION

Ürün Kodu	Product Code	010 104 000139
Ambalaj Şekli	Packing Type	Kutu - Pack
Adet	Quantity	10
Ağırlık	Weight	1,85 kg
Hacim	Volume	0,0100



MS-KY5-24 KOR. ACİL STOP BUT. (1NC) LAMB. VAVİEN (1NO) 24V KATTA LED (1NO) ALARM BUT. 16A. KAP. PRİZ HOIST 3 HOLDER

Ürün Kodu	Product Code	010 104 000140
Ambalaj Şekli	Packing Type	Kutu - Pack
Adet	Quantity	4
Ağırlık	Weight	1,35 kg
Hacim	Volume	0,0100



MS-KY3 KOR. ACİL STOP BUT. + ALARM BUT. +16A KAPAKLI PRİZ KOMBİNASYON
PROTECTED EMER. STOP BUT. (1NC) LAMP. CONTRACTOR (1NO) 24V CATA LED (1NO) ALARM BUT. 16A COVER. SOC

Ürün Kodu	Product Code	010 104 000141
Ambalaj Şekli	Packing Type	Kutu - Pack
Adet	Quantity	5
Ağırlık	Weight	1,09 kg
Hacim	Volume	0,0100



MS-KY3E55012 KOR. AXCİL STOP BUT. + ALARM+9V PİLLİ 130 dB KOMBİNASYON
PROTECTED EMER. STOP+ 9 VOLT BATTERY POWERED 130dB ALARM COMBINATION

Ürün Kodu	Product Code	010 104 000142
Ambalaj Şekli	Packing Type	Kutu - Pack
Adet	Quantity	5
Ağırlık	Weight	1,38 kg
Hacim	Volume	0,0100



MS-KY4E55012KOR. ACİL STOP BUT. +9V PİLLİ 130dB ALARM +16A KAP. PRİZ KOMBİNASYON
PROTECTED EMERGENCY STOP + 9V BATTERY POW. 130dB ALR. AND 16A COV. SOC. COMB.

Ürün Kodu	Product Code	010 104 000143
Ambalaj Şekli	Packing Type	Kutu - Pack
Adet	Quantity	4
Ağırlık	Weight	1,14 kg
Hacim	Volume	0,0100



**MS-LV4 YUKARI (1NO) AŞAĞI (1NO)
0-1 REVİZYON (1NO) ACİL STOP BUT.
(1NC) EL TERMİNALI (EL KUMANDA)**
UP (1NO) DOWN (1NO) 0-1 REVISION (1NO)
EMERGENCY STOP (1NC) (REMOTE CONTROL)

Ürün Kodu	Product Code	010 091 020001
Ambalaj Şekli	Packing Type	Kutu - Pack
Adet	Quantity	6
Ağırlık	Weight	1,40 kg
Hacim	Volume	0,0100



**MS-LV5 YUKARI (1NO) ORTAK (1NO)
AŞAĞI (1NO) 0-1 REVİZYON (1NO) ACİL STOP BUT.
(1NC) 16A KAP. PRİZ EL TERMİNALI**
UP (1NO) COM. (1NO) DOWN (1NO) 0-1 REVISION (1NO)
EMER. STOP (1NC) 16A COVERED SOC. (REMOTE CON.)

Ürün Kodu	Product Code	010 104 000145
Ambalaj Şekli	Packing Type	Kutu - Pack
Adet	Quantity	4
Ağırlık	Weight	1,16 kg
Hacim	Volume	0,0100



**MS3BY-BG53P 3KD.BY-PASSLI LAMBA BUT.
(1NO) 24V KATTA LEDLİ REG. AÇMA (1NO)
16A KAP. PRİZ KOMBİNASYON**
3KD.BYPASS LAMP BUTTON (1NO) 24V CATA
LED REG. ON (1NO) 16A COVERED SOCKET COMB.

Ürün Kodu	Product Code	010 104 000146
Ambalaj Şekli	Packing Type	Kutu - Pack
Adet	Quantity	2
Ağırlık	Weight	520 gr
Hacim	Volume	0,0100



**MS9-BX07 YUKARI (1NO) AŞAĞI (1NO) ORTAK
(1NO) 24V KATTA LEDLİ KOR. ACİL STOP (1NC)
ALR. (1NO) LAM. (1NO) KOR. 0-1 REV. (1NO) 16A**
UP (1NO) DOWN (1NO) COMMON (1NO)
24V CATA LED PROT. EMER. STOP (1NC)
ALARM (1NO) LAMP (1NO) PROT. 0-1 REV. (1NO) 16A

Ürün Kodu	Product Code	010 104 000147
Ambalaj Şekli	Packing Type	Kutu - Pack
Adet	Quantity	1
Ağırlık	Weight	300,04 gr
Hacim	Volume	0,0100



**MS102-ED21 3BYD 3KD. BYP REG.
KİL. (1NO) REG. AÇ (1NO) 24V KATTA LED
FREN AÇMA (1NO) KOR. 0-1 SET RESET (1NO)**
3BY 3KD.BYP REG. KEY (1NO)
REG. ON (1NO) 24V CATA LED BREAK ON (1NO)
PROT. 0-1 SET RESET (1NO)

Ürün Kodu	Product Code	010 104 000148
Ambalaj Şekli	Packing Type	Kutu - Pack
Adet	Quantity	1
Ağırlık	Weight	310 gr
Hacim	Volume	0,0100



**MS201-ED21 REG. AÇ KAPA (2NO) 24V KATTA
LED LAMBA BUT. (1NO) FREN AÇMA1 (1NO)
FREN AÇMA2 (1NO) KOR. SET RESET (2NO)**
REG. ON/OFF (2NO) 24V CATA LED LAMP
BUTTON (1NO) BREAK ON1 (1NO) BREAK ON2 (1NO)
PROTECTED SET RESET (2NO)

Ürün Kodu	Product Code	010 104 000149
Ambalaj Şekli	Packing Type	Kutu - Pack
Adet	Quantity	3
Ağırlık	Weight	310 gr
Hacim	Volume	0,0100



1983'ten beri...
Mutlusan[®]
electric



IP 65

2'Lİ VİNÇ KUTUSU (TEK HIZLI)
CRANE BOX, DOUBLE (SINGLE SPEED)

Ürün Kodu	Product Code	010 192 000001
Ambalaj Şekli	Packing Type	Kutu - Pack
Adet	Quantity	1
Ağırlık	Weight	400,09 gr
Hacim	Volume	0,00355
Kontakt	Contact	1N/A 1N/K 1N/O 1N/C



IP 65

3'LÜ VİNÇ KUTUSU (TEK HIZLI)
CRANE BOX, TRIPLE (SINGLE SPEED)

Ürün Kodu	Product Code	010 192 000002
Ambalaj Şekli	Packing Type	Kutu - Pack
Adet	Quantity	1
Ağırlık	Weight	480,09 gr
Hacim	Volume	0,00355
Kontakt	Contact	1N/A 1N/K 1N/O 1N/C



IP 65

4'LÜ VİNÇ KUTUSU (TEK HIZLI)
CRANE BOX, QUADRUPL (SINGLE SPEED)

Ürün Kodu	Product Code	010 192 000003
Ambalaj Şekli	Packing Type	Kutu - Pack
Adet	Quantity	1
Ağırlık	Weight	504,09 gr
Hacim	Volume	0,00355
Kontakt	Contact	1N/A 1N/K 1N/O 1N/C



IP 65

4'LÜ VİNÇ KUTUSU (TEK HIZLI)
CRANE BOX, QUINTET (SINGLE SPEED)

Ürün Kodu	Product Code	010 192 000004
Ambalaj Şekli	Packing Type	Kutu - Pack
Adet	Quantity	1
Ağırlık	Weight	564,59 gr
Hacim	Volume	0,00355
Kontakt	Contact	1N/A 1N/K 1N/O 1N/C



IP 65

6'Lİ VİNÇ KUTUSU (TEK HIZLI)
CRANE BOX, SEXTET (SINGLE SPEED)

Ürün Kodu	Product Code	010 192 000005
Ambalaj Şekli	Packing Type	Kutu - Pack
Adet	Quantity	1
Ağırlık	Weight	712,09 gr
Hacim	Volume	0,00355
Kontakt	Contact	1N/A 1N/K 1N/O 1N/C

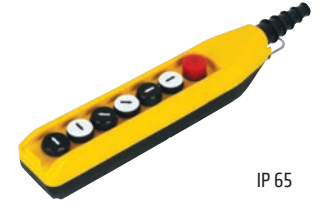

IP 65

7'Lİ VİNÇ KUTUSU (TEK HIZLI)
CRANE BOX, SEPTET (SINGLE SPEED)

Ürün Kodu	Product Code	010 192 000006
Ambalaj Şekli	Packing Type	Kutu - Pack
Adet	Quantity	1
Ağırlık	Weight	767,09 gr
Hacim	Volume	0,00355
Kontakt	Contact	1N/A 1N/K 1N/O 1N/C



MS-KY3ES5012 MLK-2 TEK HIZLI 2'Lİ LİFT KUMANDA-ÇİFT KONTAKLI-10A

PROTECTED EMER. STOP + 9V BATTERY POWERED 130dB ALARM COMBINATION

Ürün Kodu	Product Code	010 104 000142
Ambalaj Şekli	Packing Type	Kutu - Pack
Adet	Quantity	5
Ağırlık	Weight	88,04 gr
Hacim	Volume	0,0009



MS-KY4ES5012 MLK-3 TEK HIZLI 3'LÜ LİFT KUMANDA-ÇİFT KONTAKLI-10A

PROTECTED EMERGENCY STOP + 9V BATTERY POW. 130dB ALR. AND 16A COV. SOC. COMB.

Ürün Kodu	Product Code	010 104 000143
Ambalaj Şekli	Packing Type	Kutu - Pack
Adet	Quantity	4
Ağırlık	Weight	105,04 gr
Hacim	Volume	0,0009



MS-LV4 MLK-4 TEK HIZLI 4'LÜ LİFT KUMANDA-ÇİFT KONTAKLI-10A

UP(1N0) DOWN (1N0) 0-1 REVISION (1N0) EMERGENCY STOP (1NC) EMERGENCY STOP (1NC) (HAND CONTROL)

Ürün Kodu	Product Code	010 104 000152
Ambalaj Şekli	Packing Type	Kutu - Pack
Adet	Quantity	6
Ağırlık	Weight	127,04 gr
Hacim	Volume	0,0009

NOT NOTE

A series of horizontal dotted lines for writing notes, starting below the 'NOT NOTE' header and extending to the bottom of the page.

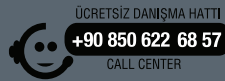

Mutlusan Plastik Elektrik San ve Tic. A.Ş.

İkitelli Org.San. Bölgesi Mahallesi Enkoop Cad.
No:7 Başakşehir- İstanbul
Tel : +90 (212) 485 05 44 (PBX)
Faks : +90 (212) 485 10 12

Karaköy Şube Karaköy Branch

Okçumusa Cad. Güneşan İş Hanı No : 24/10
Karaköy-İstanbul
Tel : +90 (212) 237 06 02 (PBX)
Faks: +90 (212) 237 77 47

Perpa Şube Perpa Branch

Perpa Tic. Merkezi. A Blok Kat: 2
No: 9-009 Okmeydanı - İstanbul
Tel : +90 (212) 320 05 78 (PBX)
Faks: +90 (212) 320 05 81

mutlusan.com.tr